

TOSHIBA

Instruction Manual

VIRTUAL REAL-TIME & TIME LAPSE VCR KV-7168A

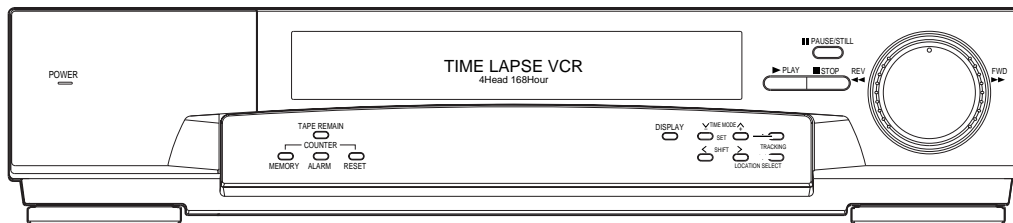

INTRODUCTION 4

PREPARATION 11

RECORDING
OPERATION 23

PLAYBACK
OPERATION 39

NOTICE 44

PLEASE READ

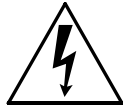
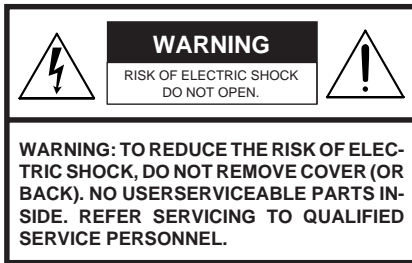

The lightning flash with arrowhead symbol, within an equilateral triangle, is intended to alert the user to the presence of uninsulated "dangerous voltage" within the product's enclosure that may be of sufficient magnitude to constitute a risk of electric shock to persons.



The exclamation point within an equilateral triangle is intended to alert the user to the presence of important operating and maintenance (servicing) instructions in the literature accompanying the appliance.

WARNING: TO REDUCE THE RISK OF FIRE OR ELECTRIC SHOCK, DO NOT EXPOSE THIS APPLIANCE TO RAIN OR MOISTURE. DANGEROUS HIGH VOLTAGES ARE PRESENT INSIDE THE ENCLOSURE. DO NOT OPEN THE CABINET. REFER SERVICING TO QUALIFIED PERSONNEL ONLY.

CAUTION: TO PREVENT ELECTRIC SHOCK, MATCH WIDE BLADE OF PLUG TO WIDE SLOT, FULLY INSERT.

ATTENTION: POUR ÉVITER LES CHOCS ÉLECTRIQUES, INTRODUIRE LA LAME LA PLUS LARGE DE LA FICHE DANS LA BORNE CORRESPONDANTE DE LA PRISE ET POUSSER JUSQU'AU FOND.

USER-INSTALLER CAUTION : YOUR AUTHORITY TO OPERATE THIS FCC VERIFIED EQUIPMENT CANNOT BE VOIDED IF YOU MAKE CHANGES OR MODIFICATIONS NOT EXPRESSLY APPROVED BY THIS PARTY RESPONSIBLE FOR COMPLIANCE TO PART 15 OF THE FCC RULES.

NOTE: This equipment has been tested and found to comply with the limits for Class A digital device, pursuant to Part 15 of the FCC Rules. These limits are designed to provide reasonable protection against harmful interference when the equipment is operated in a commercial environment. This equipment generates, uses, and can radiate radio frequency energy and, if not installed and used in accordance with the instruction manual, may cause harmful interference to radio communications. Operation of this equipment in a residential area is likely to cause harmful interference in which case the user will be required to correct the interference at his own expense.

In the spaces provided below, record the Model and Serial No. located at the rear of your video cassette recorder.

Model No. _____ Serial No. _____

Retain this information for future reference.

IMPORTANT PRECAUTIONS

Only cassettes marked **VHS** can be used with this VCR.

This VCR is not compatible with ordinary **VHS** VCRs.

Save Original Packing Materials

The original shipping carton and packing materials will come in handy if you ever have to ship your VCR. For maximum protection, repack the set as it was originally packed at the factory.

Cassette Tape

In order to maintain recorded content and machine itself, and to prevent troubles, the use of high quality video cassette tape is recommended. Tapes which have been used for long period, used repeatedly, or kept in an unpreferable condition such as high temperature, high humidity, or strong magnetic field may cause deterioration of picture quality and some troubles. We therefore recommend use of T-120 video tapes.

Dew Condensation

Never operate this VCR immediately after moving it from a cold location to a warm location. When the VCR is exposed to such a change in temperature, dew condensation may occur on the cylinder inside it, one of its most crucial internal parts. The VCR is equipped with an automatic dew condensation prevention circuit designed to cope with this problem. It takes about TWO HOURS for this circuit to work with the power cord plugged in. Please do not use the VCR during this time.

Daily Maintenance

Before beginning the day's operation, rewind the cassette tape recorded on the previous day a few counts and play it back to check for proper recording.

Copyright: To record video tapes and other material only in the event that third party copyrights and other rights are not violated.

IMPORTANT SAFETY INSTRUCTIONS

CAUTION: PLEASE READ AND OBSERVE ALL WARNINGS AND INSTRUCTIONS GIVEN IN THIS OWNER'S MANUAL AND THOSE MARKED ON THE UNIT. RETAIN THIS BOOKLET FOR FUTURE REFERENCE.

This set has been designed and manufactured to assure personal safety. Improper use can result in electric shock or fire hazard. The safeguards incorporated in this unit will protect you if you observe the following procedures for installation, use and servicing. This unit is fully transistorized and does not contain any parts that can be repaired by the user.

DO NOT REMOVE THE CABINET COVER, OR YOU MAY BE EXPOSED TO DANGEROUS VOLTAGE. REFER SERVICING TO QUALIFIED SERVICE PERSONNEL ONLY.

1. Read owner's manual

After unpacking this product, read the owner's manual carefully, and follow all the operating and other instructions.

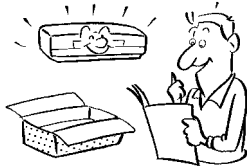

5. Heat

The product should be situated away from heat sources such as radiators, heat registers, stoves, or other products (including amplifiers) that produce heat.

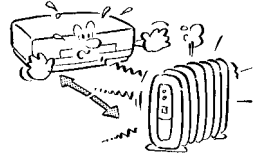

2. Power Sources

This product should be operated only from the type of power source indicated on the marking label. If you are not sure of the type of power supply to your home, consult your product dealer or local power company. For products intended to operate from battery power, or other sources, refer to the operating instructions.

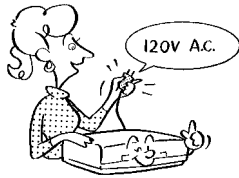

6. Water and Moisture

Do not use this product near water - for example, near a bath tub, wash bowl, kitchen sink, or laundry tub; in a wet basement; or near a swimming pool and the like.

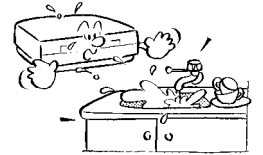

3. Grounding or Polarization

This product may be equipped with a polarized alternating current line plug (a plug having one blade wider than the other). This plug will fit into the power outlet only one way. This is a safety feature. If you are unable to insert the plug fully into the outlet, try reversing the plug. If the plug should still fail to fit, contact your electrician to replace your obsolete outlet. Do not defeat the safety purpose of the polarized plug.

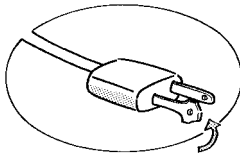

7. Cleaning

Unplug this product from the wall outlet before cleaning. Do not use liquid cleaners or aerosol cleaners. Use a damp cloth for cleaning.

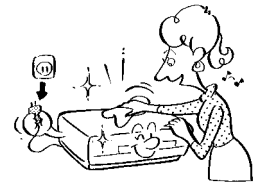

4. Ventilation

Slots and openings in the cabinet are provided for ventilation and to ensure reliable operation of the product and to protect it from overheating, and these openings must not be blocked or covered. The openings should never be blocked by placing the product on a bed, sofa, rug or other similar surface. This product should not be placed in a built-in installation such as a bookcase or rack unless proper ventilation is provided or the manufacturer's instructions have been adhered to.

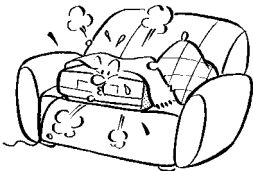

8. Power-Cord Protection

Power-supply cords should be routed so that they are not likely to be walked on or pinched by items placed upon or against them, paying particular attention to cords at plugs, convenience receptacles, and the point where they exit from the product.



9. Overloading

Do not overload wall outlets; extension cords, or integral convenience receptacles as this can result in a risk of fire or electric shock.

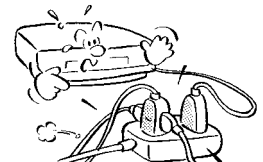

INTRODUCTION

FEATURES

- **Various time modes.**
With a T-120 tape, it is possible to record over periods ranging from 2 to 168 hours.
A2, A6, A12, A18, A24, 24, 48, 72, 120 and 168 modes are explained in more detail. (See page 21.)
- **Virtual real-time recording is possible.**
It is possible to virtual real-time record in A18 mode. (See page 21.)
- **Internal time-date generator.**
This VCR includes an internal time-date generator, necessary for documentation purposes. (See page 15.)
- **On-screen programming.**
Menu driven programming simplifies set-up of various functions including but not limited to the following:
time & date search, timer setting, and alarm recording.
- **Timer recording function.**
With timer recording, it is possible to set two programs for each day of the week as well as one daily program. Up to 15 programs total are available for timer recording. (See pages 25 - 28.)
- **Tape remaining function.**
With this feature, it is possible to check the time remaining until the end of tape during the recording process as well as playback process. (See page 6, note ②.)
- **Alarm record function.**
With a dry contact closure upon the alarm input terminal, it is possible to set the VCR into alarm mode. When recording in the alarm mode, the VCR automatically enters into a mode which usually is a faster recording mode. This is done so that more information can be recorded.
- **One-shot recording possible.**
External trigger input makes it possible to record from 1 to 32 fields and Manual mode.
- **Alarm memory search function.**
This VCR provides an alarm memory function for finding the alarm event during playback. (See page 43.)
- **Repeat record function.**
Repeat record function enables the VCR to automatically rewind the tape when it reaches the end and restarts the recording process. (See page 36.)
- **Restart record function.**
This function enables the VCR to automatically restart the recording process in the event of a power failure. After power is restored, the VCR will restart the recording process. (See page 24.)
- **Shuttle function.**
With the shuttle dial, a wide variety of playback functions are available. They include picture search, slow playback, field advance playback, reverse field advance playback, and still playback (See pages 40 - 41.)
- **Clean slow and still.**
A clean crisp image is crucial and is the main purpose for the existence of a surveillance recorder. This VCR offers a clean and noiseless playback, that is essential for surveillance applications.
- **Time date search function.**
With time date search, it is possible to search for a picture recorded on a certain time and date. (See page 42.)
- **Head cleaning function.**
Head cleaning is automatically performed at the end of timer recording and at tape end in order to prevent head jamming. There is also head cleaning once every two hours when operating in time modes of 24 hours or more.
- **Automatic head clog detection.**
When recording in time mode 120 and 168 hours or in the One-shot mode, video head clog detection is automatically carried out once for every two hours. When the video head clog is found, head cleaning is carried out for approximately 10 times. When cleaning is still not possible, "E-6" is displayed.
- **Record check function.**
By pressing the record check button during recording, the VCR automatically replays the last few seconds of the recording. (See page 5, note ②).
- **Wired remote control function (Option)**
The wired remote control allows the following VCR functions.
 - Fast Forward • Forward picture search
 - Rewind • Reverse picture search
 - Pause • Still
 - Field advance (forward, reverse)
 - Play • Stop
 - Play back time

TABLE OF CONTENTS

PLEASE READ	1	RESTART RECORDING	24
IMPORTANT PRECAUTIONS	1	TIMER RECORDING	25
IMPORTANT SAFETY INSTRUCTIONS	2 ~ 3	ALARM RECORDING	29
INTRODUCTION	4 ~ 10	ONE SHOT RECORDING	31
FEATURES	4	SETTING OF OPERATION AFTER TAPE END DETECTION	34
TABLE OF CONTENTS	4	AUTO REWIND AFTER RECORDING	35
INSTRUCTIONS IN BRIEF	5	REPEAT RECORDING	36
VCR DISPLAY	9	RECORDING WITH THE SEQUENTIAL SWITCHER	37
WIRED REMOTE CONTROL (Option)	10	PLAYBACK OPERATION	39 ~ 43
PREPARATION	11 ~ 22	PLAYBACK	39
CONNECTIONS	11	PLAYBACK IN VARIOUS MODE	41
CONTENTS OF SCREEN DISPLAY	13	TIME DATE SEARCH	42
SETTING THE CLOCK	15	ALARM SEARCH	43
ON-SCREEN FUNCTIONS	16	NOTICE	44 ~ 50
DISPLAY SCREEN	17	SIGNAL LEVELS OF INPUT/OUTPUT	44
COUNTER DISPLAY	19	DAILY AND PERIODIC INSPECTION	45
SETTING THE RECORDING/PLAYBACK TIME	21	CAUTIONS DURING USE	47
LOADING AND UNLOADING A VIDEO CASSETTE	22	BEFORE CALLING SERVICE PERSONNEL	48
RECORDING OPERATION	23 ~ 38	SPECIFICATIONS	50
RECORDING	23		

INSTRUCTIONS IN BRIEF

Front Panel

- ⑫ **TAPE REMAIN button**
The approximate time remaining on the tape is displayed on the counter (in a 2 hour scale using a T-120 tape) while this button is being pressed.
- ⑬ **CASSETTE COMPARTMENT**
Insert a cassette into this compartment to load the tape.
- ⑭ **DISPLAY button**
Press to display the MENU screen and change the settings.
- ⑮ **SHIFT < / > button**
Press to select a desired menu on the screen.
- ⑯ **TIME MODE ^ v / SET + - buttons**
- Press either of the buttons to set the recording time mode and playback time mode.
 - Press either the + or the - button to set the mode and the numerical value for each menu on the screen.
- ⑰ **LOCATION SELECT button > / v**
Press to change the position of superimposed characters on the screen.
- ⑱ **TRACKING buttons (^ / v)**
Adjust to eliminate noise from playback picture.
- ⑲ **PLAY button**
Press to start the playback mode.
- ⑳ **STOP button**
Press to stop tape running.
- ㉑ **PAUSE/STILL button**
- Press during recording to pause recording.
 - Press during playback for a still picture.
- ㉒ **SHUTTLE dial**
Turn this dial clockwise and hold:
- To fast forward the tape during the stop mode.
 - To operate the forward picture search during the playback.
 - To operate the forward slow play during the still mode.
- Turn this dial counter clockwise and hold:
- To rewind the tape during the stop mode.
 - To operate the reverse picture search during the playback.
 - To operate the reverse slow play during the still mode.

Rear Panel

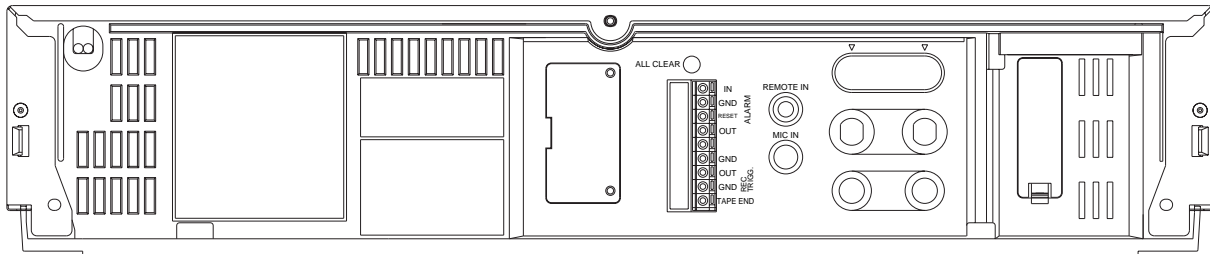

- ① **TAPE END OUT terminal**
Signal output terminal to announce to other devices that the tape has run out on the VCR.
- ② **REC TRIGGER OUT terminal**
Signal output terminal to control the switching interval of the video cameras when connected to a sequential switcher or multiplexer.
- ③ **ALARM OUT terminal**
Output terminal to transmit an alarm signal to peripheral equipment.
- ④ **ALARM RESET terminal**
Input terminal to reset alarm recording.
Alarm recording is reset when this terminal is connected to the ground terminal during recording.
- ⑤ **ALARM IN terminal**
Input terminal to start alarm recording.
The VCR goes into alarm recording mode when this terminal is connected to the ground terminal while in the record mode, record pause mode, or stop mode.
- ⑥ **ALL CLEAR button**
Pressing this button will clear the entire time-date, and timer program memory. The power will be turned off at the same time. Pressing the **POWER** button will restore power.
- ⑦ **REMOTE IN jack**
Input jack for optional wired remote control.
- ⑧ **MIC IN jack**
Input jack for audio signals from a microphone. The RCA jack input (audio input) is automatically switched off when this jack is utilized.
- ⑨ **VIDEO IN connector (BNC)**
Input connector for video signal. Connect with an external video source such as a video camera, etc.
- ⑩ **VIDEO OUT connector (BNC)**
Output connector for video signal. Connect with a monitor TV.
- ⑪ **AUDIO IN jack (RCA type)**
Input jack for audio signal. Connect with an external audio source.
- ⑫ **AUDIO OUT jack (RCA type)**
Output jack for audio signal. Connect with an external audio equipment.
- ⑬ **ONE SHOT IN terminal**
Input terminal to start one shot recording.
The VCR goes into one shot recording mode when this terminal is connected to the ground terminal while in the L01, L02 or L03 record mode.

Notes:

- **ALL CLEAR button**
Do not use this function (ALL CLEAR) frequently.
Press this button only when an abnormality (ex. VCR display does not turn ON.) occurs.
When this button is pressed, the power turns OFF and each data stored (ex. clock, timer program, etc.) is cleared and returns to the initial setting status. It will be necessary to re-program the VCR after turning the unit on again.
- **OPTION BOX cover**
This VCR provides an optional port for connecting an optional module to the rear of the unit.
If you would like additional information regarding the available options for this VCR please consult your dealer.
The installation of the optional module should be performed only by qualified technical personnel.

A Word on the Exclusive 3N-100AAS Battery Pack

The nickel-cadmium battery pack (3N-100AAS) is used for power source of the built-in clock and memory circuit.

Charging the Battery Pack

1. Turn on the power of the VCR.
2. The battery pack in the VCR is charged.

Battery Installation

Removal:

1. Remove the battery cover.
2. Disconnect the connector in the VCR.

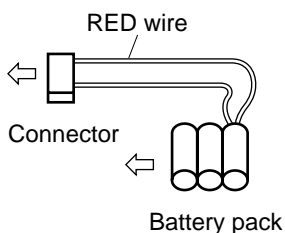

Installation:

1. Install the battery pack placing the red wire upside, and connect the connector on the battery pack to this VCR. Make sure the polarities (+) and (-) are correct.
2. Close the battery cover.

Note:

If the Battery Pack is removed, the memory data will be erased. In such a case, perform the setting from the first step.

Specification of Battery

- Temperature
 - For charging : 0°C to 80°C
 - For operating : -20°C to 80°C
 - For storing : -30°C to 80°C
- Charging time : more than 48 hours

Notes:

- Use only for this VCR.
- Do not dispose of the batteries into fire.
- Do not short circuit the terminals.
- Do not modify or disassemble.
- Avoid dropping, unnecessary shocks.

VCR DISPLAY

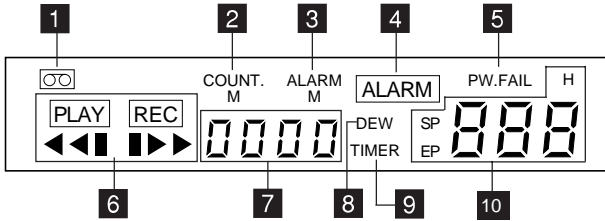

1 Cassette indicator

Lights when a tape is inserted.

2 Counter memory indicator

Lights when the counter memory is selected.

3 Alarm Memory indicator

Lights when the alarm memory is selected.

4 Alarm indicator

Lights during alarm recording and blinks after an alarm recording cycle is completed.

5 PW.FAIL (Power Failure) indicator

Blinks when a power failure occurs.

6 TAPE operation indicator

Displays as shown below, depending on operational modes.

Playback		Other than playback	
Playback	PLAY ▶	Record	REC ▶
Still	PLAY 	Pause	REC
Slow	PLAY I ▶	Time-lapse	REC I ▶
Field Advance	PLAY II ▶	Fast Forward	▶▶
Reverse Playback	PLAY ◀	Rewind	◀◀
Forward Picture Search	PLAY ▶▶		
Reverse Picture Search	PLAY ◀◀		
Reverse Field Advance	PLAY ◀		

7 Counter/Alarm Counter/Remaining Tape/Error Message indicator

- Press the **ALARM** button to display the alarm counter.
- Press the **ALARM** button again to return to display the counter.
- Press the **TAPE REMAIN** button to display the remaining tape time.
- When an abnormality occurs during operation, the error code is displayed.

E-1: Abnormality on reel rotation during tape running.

E-3: Abnormality on cylinder rotation during recording and playback.

E-4: Abnormality on tape loading mechanism.

E-5: Video tape is cut.

E-6: Head clog.

E-8: Dew condensation.

8 Dew indicator

Blinks when the dew condensation has developed inside the VCR.

9 Timer indicator

Lights when the timer recording button is pressed and the VCR has been set in timer record mode.

10 Record/Playback Time indicator

Displays record/playback time mode.

WIRED REMOTE CONTROL (Option)

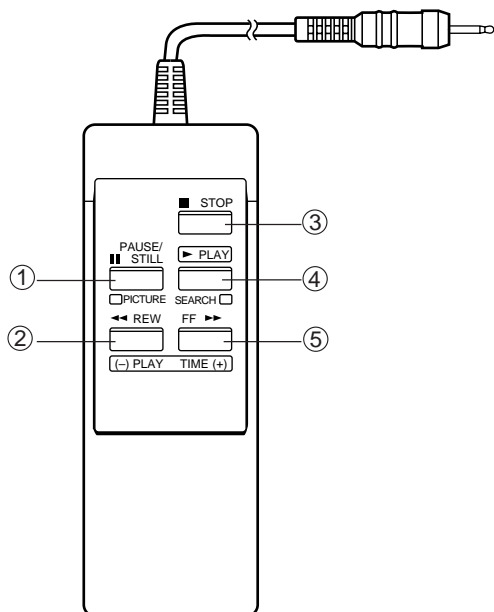

- ① **PAUSE/STILL button**
 - Press during recording to pause the recording.
 - Press during playback to play back a still picture.
- ② **REW button**
 - Press to rewind the tape.
 - Press during playback for reverse picture search. To release the reverse picture search mode, press the **PLAY** button.
 - Press the **REW** button while pressing the **PLAY** button, the time mode can be selected.
 - Each time pressing the **REW** button during still playback mode, the Reverse Field Advance playback (one field) will be carried out.
- ③ **STOP button**

Press to stop tape running.
- ④ **PLAY button**

Press to start play back.
- ⑤ **FF button**
 - Press to fast forward mode.
 - Press during playback for forward picture search mode. To release the forward picture search mode, press the **PLAY** button.
 - Press the **FF** button while pressing the **PLAY** button, the Time mode can be selected.
 - Each time pressing the **FF** button during still playback mode, the Field Advance playback (one field) will be carried out.

Note: _____
 If your wish to obtain the wired remote control, please consult your dealer.

PREPARATION

CONNECTIONS

Connection with a Video Camera

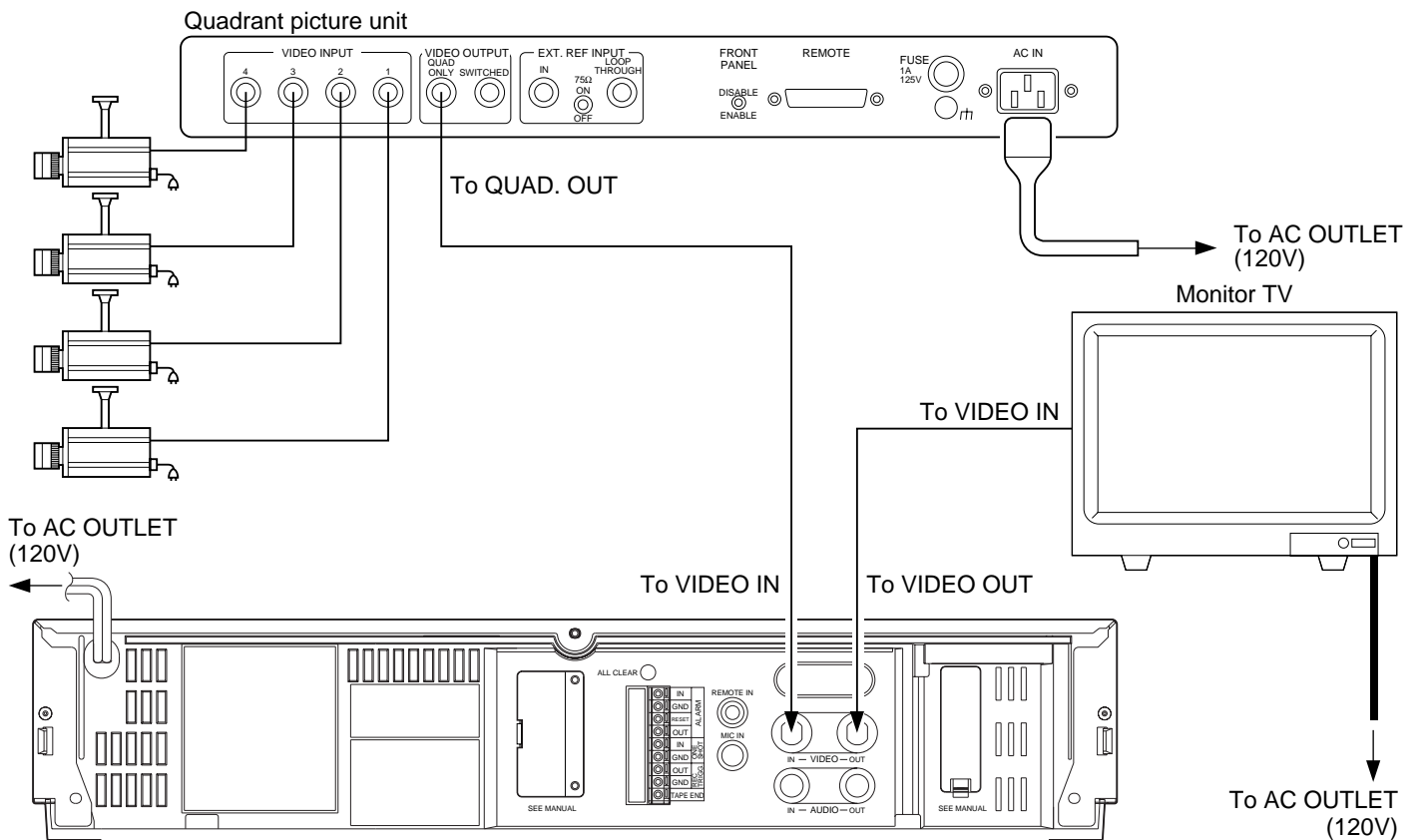
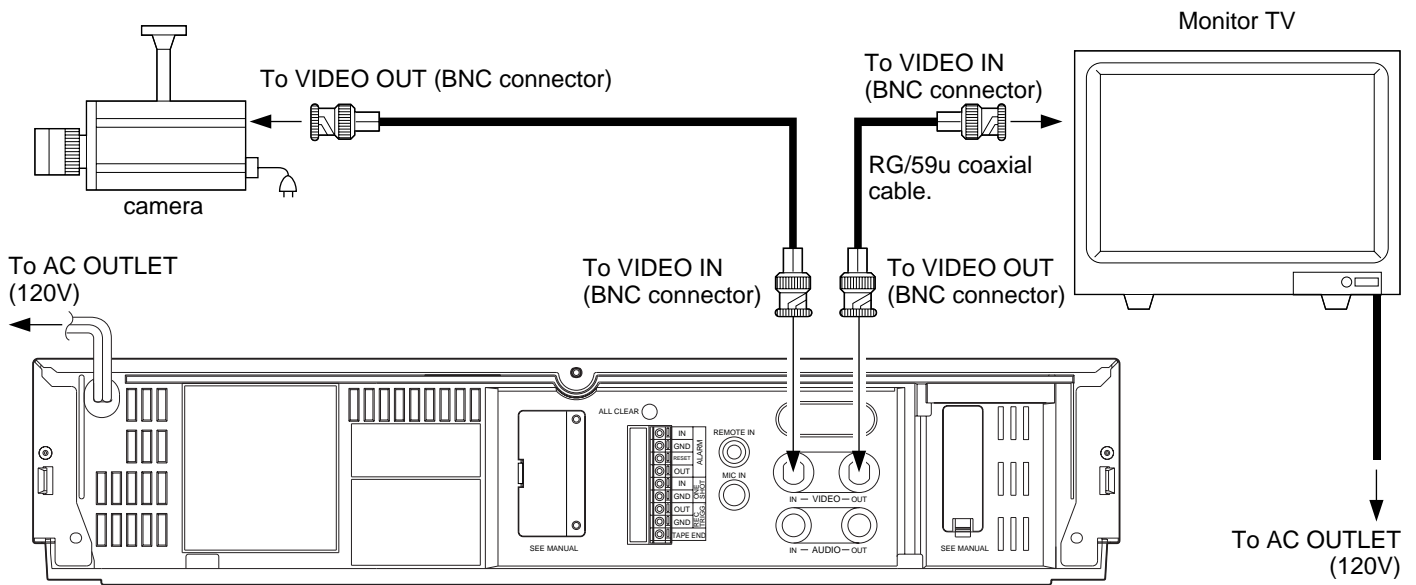

Typical Connection with the Sequential Switcher

When connected with a sequential switcher, set the alarm recording mode to MANUAL by menu screen.
For further details, consult the instruction manuals of the connected devices.

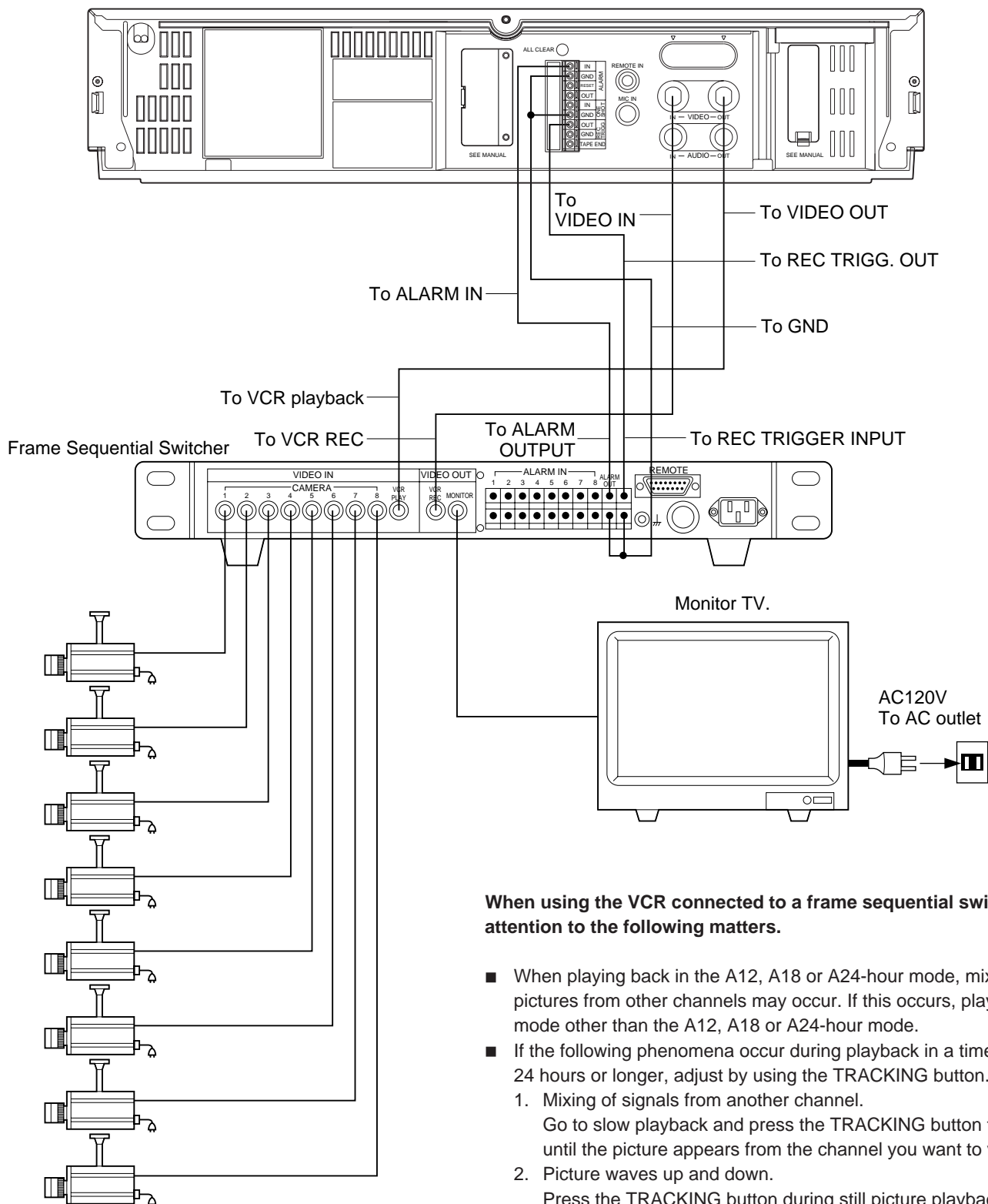

When using the VCR connected to a frame sequential switcher, pay attention to the following matters.

- When playing back in the A12, A18 or A24-hour mode, mixing of pictures from other channels may occur. If this occurs, play back in a mode other than the A12, A18 or A24-hour mode.
- If the following phenomena occur during playback in a time mode of 24 hours or longer, adjust by using the TRACKING button.
 1. Mixing of signals from another channel.
Go to slow playback and press the TRACKING button to adjust until the picture appears from the channel you want to view.
 2. Picture waves up and down.
Press the TRACKING button during still picture playback and adjust the picture until the picture stops waving up and down.

CONTENTS OF SCREEN DISPLAY

The normal MENU screen provides six menus after the initial screen for clock setting. Each MENU screen is shown below. Press the **DISPLAY** button for a MENU screen. The menu is selected by pressing the **SHIFT** button. Then press the **SET** button to proceed to the next screen. Use the **SHIFT** button and the **SET** button for settings and adjustments in the same manner. To return to the initial screen press the **DISPLAY** button.

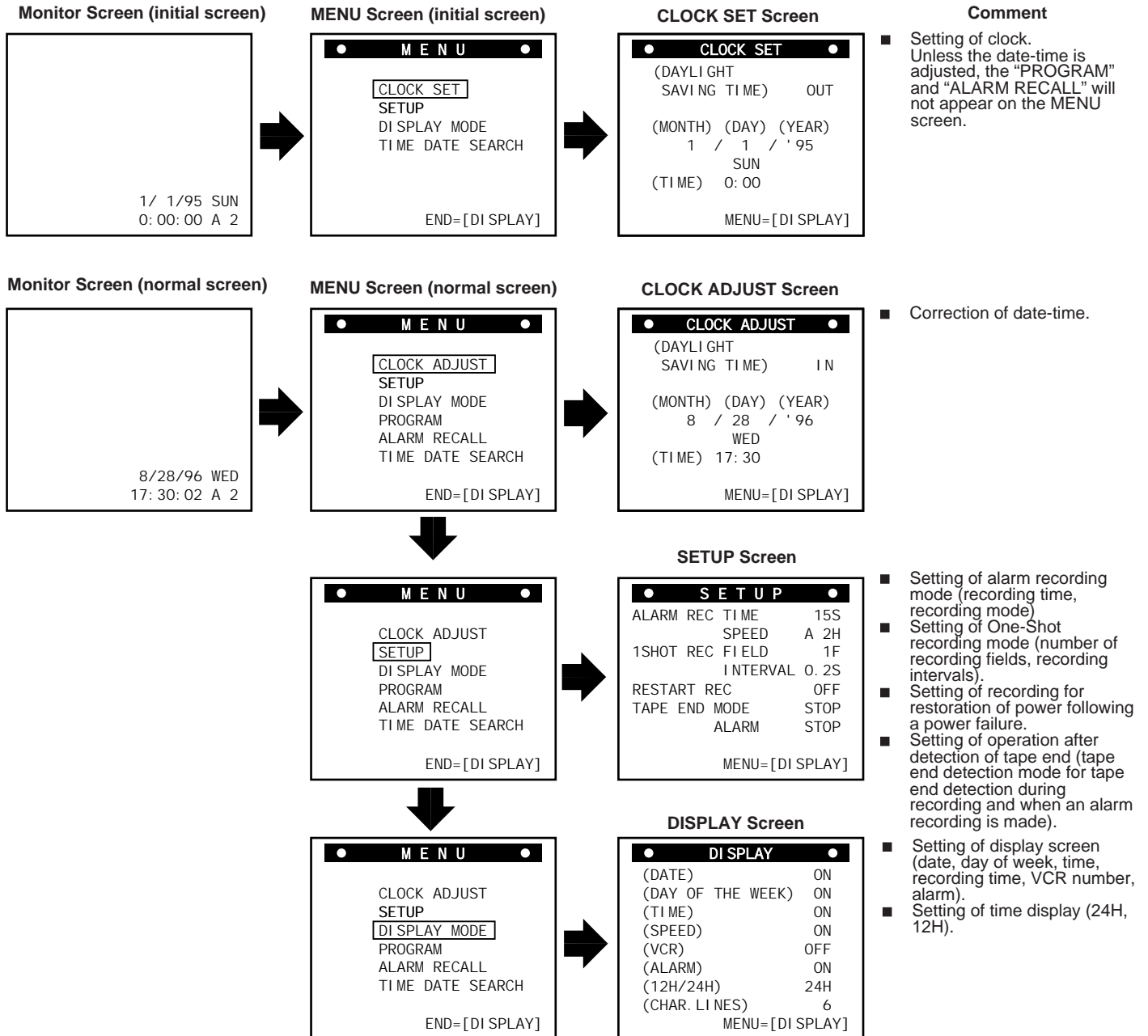

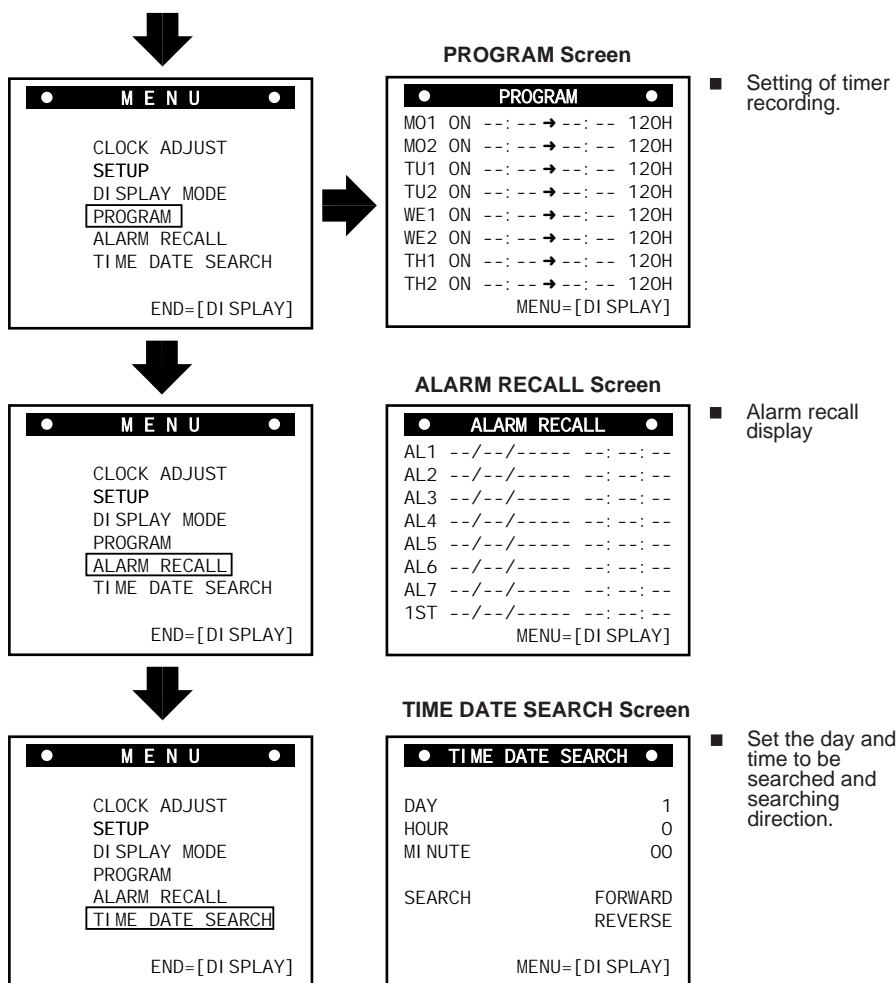

SETTING THE CLOCK

An internal clock generates time and date for superimposing on the monitor screen. Adjust the time from the MENU screen (initial screen). After the clock is set, the data and time modes are displayed on the monitor screen (live picture).

Operation

In case of setting to 5:30 PM, Wednesday, August 28, 1996;

1 Press the **DISPLAY** button.

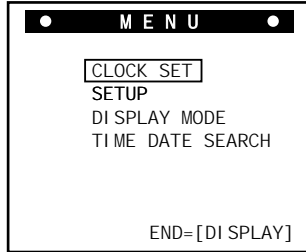
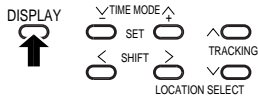

2 Press the **+ SET** button.

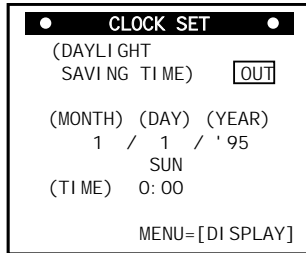
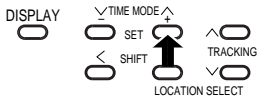

3 Press the **+ SET** button and set the **DAYLIGHT SAVING TIME** to **IN**.

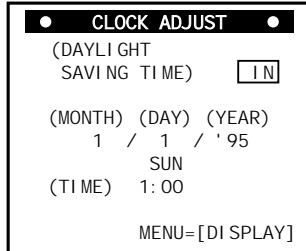
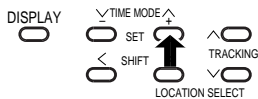

4 Press the **> SHIFT** button to blink **Month** and press the **+ SET** button to set to **"8"**.

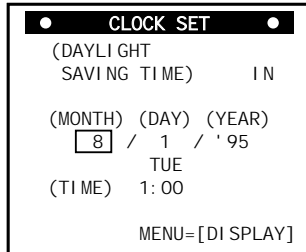
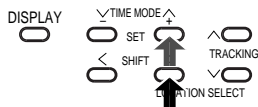

5 Press the **> SHIFT** button to blink **Day** and press the **+ SET** button to set to **"28"**.

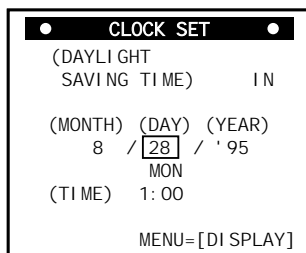
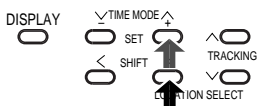

6 Press the **> SHIFT** button to blink **Year** and press the **+ or - SET** button to set to **"96"**.

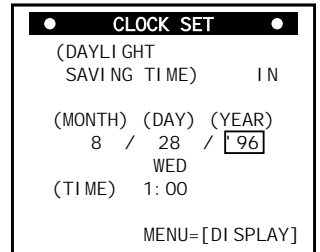
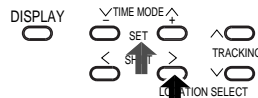

7 Press the **> SHIFT** button to blink **Time in hours** and press the **+ SET** button to set to **"17"**.

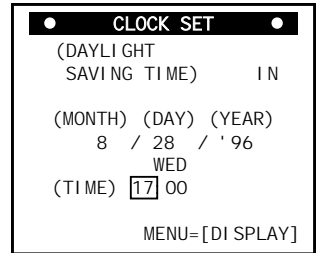
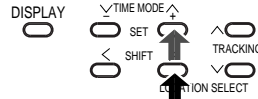

8 Press the **> SHIFT** button to blink **Time in minutes** and press the **+ SET** button to set to **"30"**.

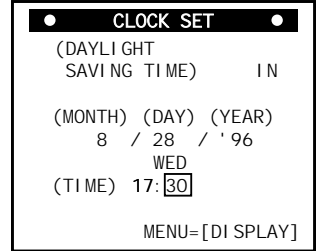
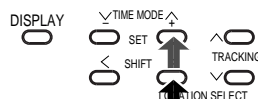

9 Press the **DISPLAY** button to start display of the set date and time.

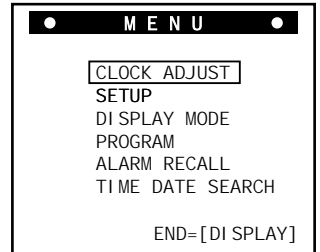
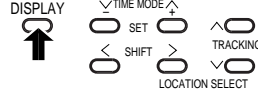

10 Press the **DISPLAY** button to return to the normal screen.

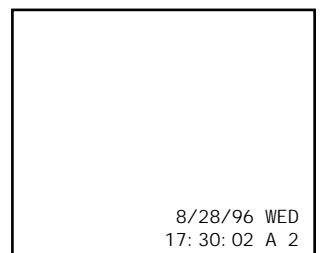
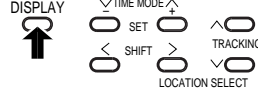

ON-SCREEN FUNCTIONS

When the power is turned ON, the time and date modes are displayed on the monitor screen (live picture). On-screen displays are not available in the event of no video input signal.

Date-Time Display

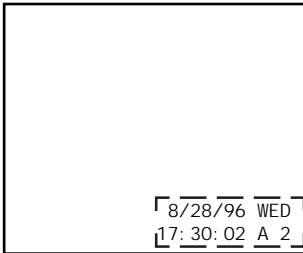

Monitor screen

VCR display

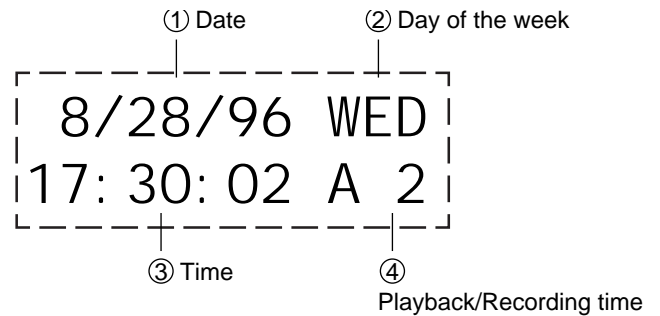

- ① Date : Displayed with the month-day-year.
- ② Day of the week : Automatically set to the correct day of the week when the date is set.
- ③ Time : Set to 24-hour cycle at factory.
It is possible to modify to 12-hour (AM/PM) cycle display.
- ④ Playback/Recording Time : Playback or Recording time display

On-Screen Position

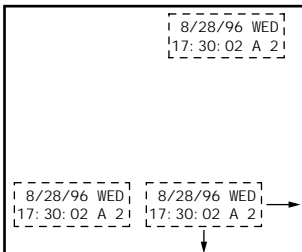

Press the **LOCATION SELECT** button to adjust the display to desirable position.
The display moves in the direction shown by the arrows.

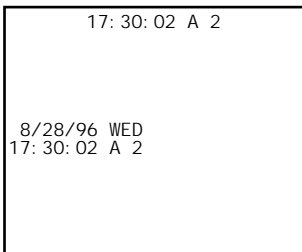
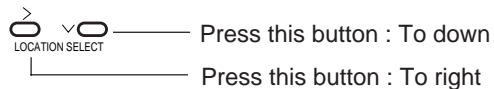

However, during the date-time display screen, pay attention to the following when setting the date and time display positions:
When the display is set to an end of the monitor screen as shown in the figure, synchronization instability or color flickering may occur in some monitor TVs.

DISPLAY SCREEN

Set the MENU screen to DISPLAY screen, and select or set each item.
 Before operation, set the MENU screen to DISPLAY screen (See page 13.).

Note:

Press the **DISPLAY** button twice to return from the display screen to the monitor screen.

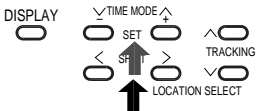
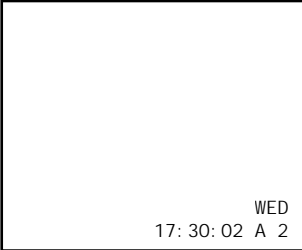
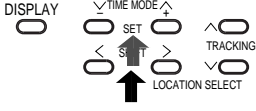
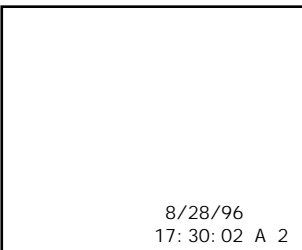
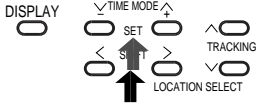
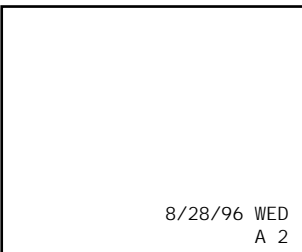
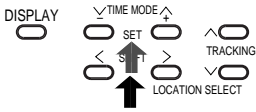
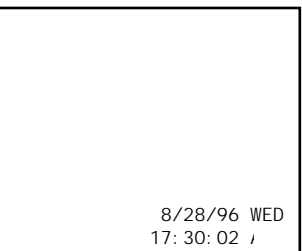
Operation	Display Screen	Monitor Screen
<p>Erasing the date display.</p> <p>Press the < or > SHIFT button to blink DATE and press the + or - SET button to go to OFF.</p>  <p>Changes between OFF and ON each time the + or - SET button is pressed.</p>	<pre> ● DI SPLAY ● (DATE) OFF (DAY OF THE WEEK) ON (TIME) ON (SPEED) ON (VCR) OFF (ALARM) ON (12H/24H) 24H (CHAR. LI NES) 6 MENU=[DI SPLAY] </pre>	
<p>Erasing the day of the week display.</p> <p>Press the < or > SHIFT button to blink DAY OF THE WEEK and press the + or - SET button to go to OFF.</p>  <p>Changes between OFF and ON each time the SET button is pressed.</p>	<pre> ● DI SPLAY ● (DATE) ON (DAY OF THE WEEK) OFF (TIME) ON (SPEED) ON (VCR) OFF (ALARM) ON (12H/24H) 24H (CHAR. LI NES) 6 MENU=[DI SPLAY] </pre>	
<p>Erasing the time display.</p> <p>Press the < or > SHIFT button to blink TIME and press the + or - SET button to go to OFF.</p>  <p>Changes between OFF and ON each time the + or - SET button is pressed.</p>	<pre> ● DI SPLAY ● (DATE) ON (DAY OF THE WEEK) ON (TIME) OFF (SPEED) ON (VCR) OFF (ALARM) ON (12H/24H) 24H (CHAR. LI NES) 6 MENU=[DI SPLAY] </pre>	
<p>Erasing the speed display.</p> <p>Press the < or > SHIFT button to blink SPEED and press the + or - SET button to go to OFF.</p>  <p>Changes between OFF and ON each time the + or - SET button is pressed.</p>	<pre> ● DI SPLAY ● (DATE) ON (DAY OF THE WEEK) ON (TIME) ON (SPEED) OFF (VCR) OFF (ALARM) ON (12H/24H) 24H (CHAR. LI NES) 6 MENU=[DI SPLAY] </pre>	

Note:

Press the **DISPLAY** button twice to return from the display screen to the monitor screen.

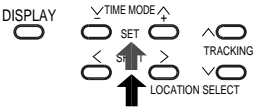
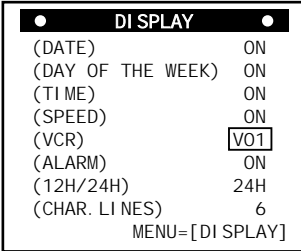
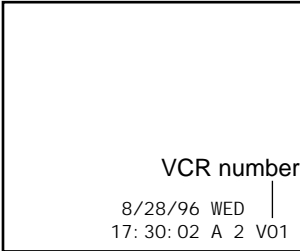
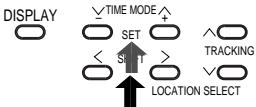
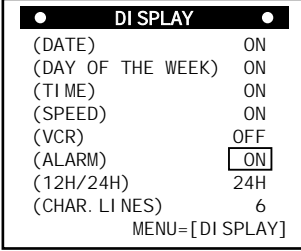
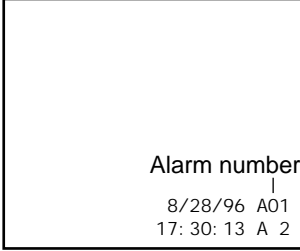
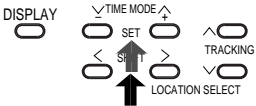
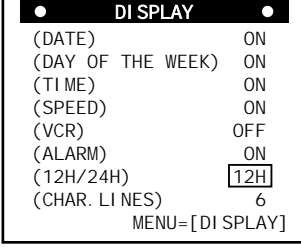
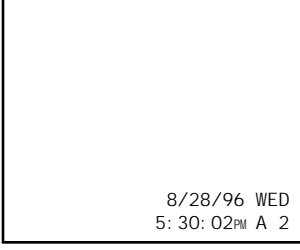
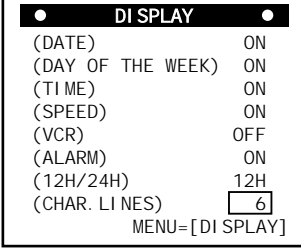
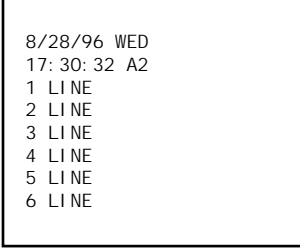
Operation	Display Screen	Monitor Screen
<p>Displaying the VCR number.</p> <p>Press the < or > SHIFT button to blink VCR and press the + or - SET button to set the VCR number.</p>  <p>Changes as shown below each time the SET button is pressed.</p> <p>OFF → V01 → V02 → V03 → V04 → V05 → V06 → V07 → V08 → OFF</p>		
<p>Displaying the number of alarms.</p> <p>Press the < or > SHIFT button to blink ALARM and press the + or - SET button to go to OFF.</p>  <p>Changes between OFF and ON each time the + or - SET button is pressed. When an alarm is input, the day of the week display changes to the alarm number.</p>		
<p>Displaying the hour display.</p> <p>Press the < or > SHIFT button to blink (12H/24H) and press the + or - SET button to go to 12H.</p>  <p>Changes between 12H and 24H each time the + or - SET button is pressed.</p>		
<p>This function enables to indicate and record information from cash register or ATM using a specified option box.</p> <ol style="list-style-type: none"> Press the < or > SHIFT button to blink CHAR.LINES and the + or - button to go to "6". Press the + or - button to select the characters of line number. Each time pressing the + or - SET button, the display changes as follows. <p>If you select</p> <p>[DATE] ON: } 6→1→2→3→4→5</p> <p>[TIME] ON: }</p> <p>[DATE] OFF: } 6→7→8→1→2→3→4→5</p> <p>[TIME] OFF: }</p>		

COUNTER DISPLAYS

Counter Memory

When the counter is set to "0000" at a location that you want to see again during recording and playback, the tape will stop in the vicinity of "0000" during rewind and fast forward.

- 1 When the alarm counter is displayed, press the **ALARM** button to set the display to the counter display.

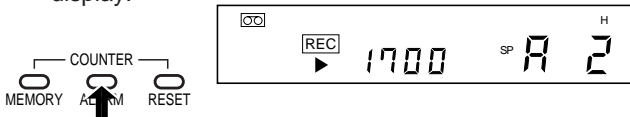

- 3 Press the **COUNTER MEMORY** button to make "COUNT.M" (Counter Memory) to light.

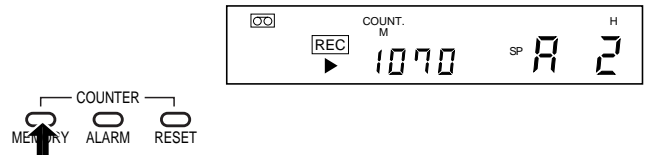

- 2 Press the **RESET** button at the location you want to see.

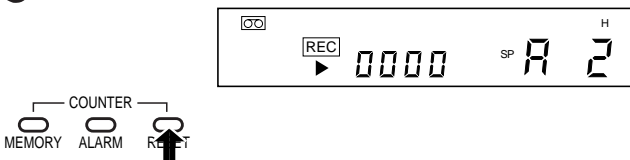

- 4 Turn the **SHUTTLE** dial to set rewind or fast forward after **STOP** button is pressed.

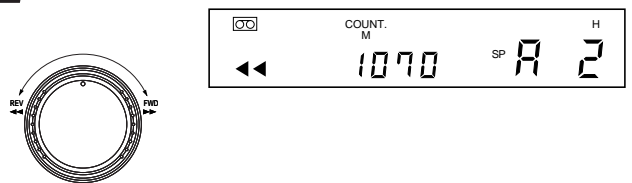

Alarm Memory

When you want to view the location where alarm recording was performed.

- 1 Press the **STOP** button.

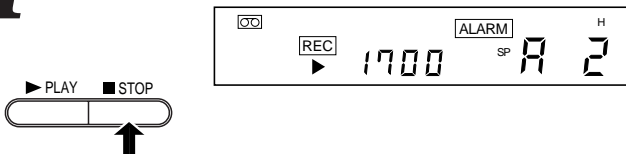

- 3 Turn the **SHUTTLE** dial to set rewind or fast forward.

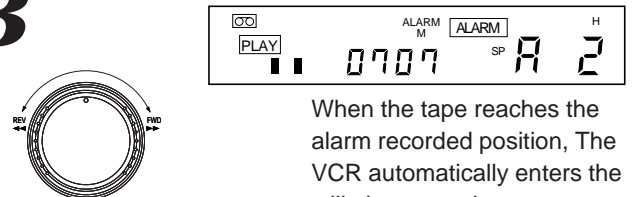

When the tape reaches the alarm recorded position, The VCR automatically enters the still picture mode.

- 2 Press the **COUNTER MEMORY** button twice to make "ALARM.M" to light.

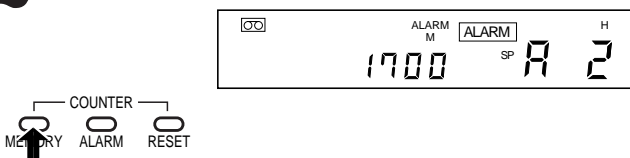

- 4 Press the **PLAY** button.

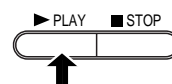

Notes:

In the cases shown below, Alarm Memory search may be not carried out.

- If the alarm recording is not carried out for more than those listed in the following chart then, the alarm may be skipped.
- If the alarm recording interval is not left for more than those listed in the following chart then, the alarm may be skipped.
- If there is not enough time between the beginning of the alarm search and the first alarm activation. If the time period is shorter than those listed in the following chart then, the first alarm may be skipped.

Record mode	Minimum alarm recording time needed	Minimum alarm recording interval needed	Minimum recording time needed between start of search and first alarm activations
A2 or A6	2 s	7 s	5 s
A12	15 s	50 s	35 s
A18	7 s	25 s	15 s
A24	30 s	95 s	65 s

Tape Remain

When the **TAPE REMAIN** button is depressed during recording or playback, the counter display changes to the remaining tape display. The remaining time is the approximately estimated time in the A2-hour mode to tape end.

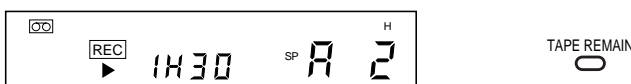

- The remaining time is the approximate remaining time.
- Displays the remaining tape time estimated in the A2-hour mode.

During computation of the remaining time, the following display appears.

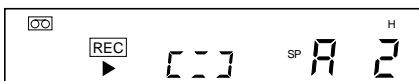

- When the VCR has been used in the recording mode over a long period, it may take considerable time for computation. When operating at fast speed in the A2-hour mode, the computation is faster.

Note:

It is possible to compute the remaining time for T-120, T-90, T-60 and T-30 tape. The display will not be correct for other kinds of tape.

Error Message

When an abnormality occurs during operation, the error code is displayed. At the same time, the buzzer will sound continuously.

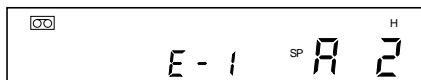

Code Number	Condition of Abnormality
E-1	Abnormality on reel rotation during tape running.
E-3	Abnormality on cylinder rotation during recording and playback.
E-4	Abnormality on tape loading mechanism.
E-5	Video tape is cut.
E-6	Head clog.
E-8	Dew condensation.

- When the error code "E-1" to "E-4" are displayed, consult with your dealer.
- When the error code "E-5" is displayed, the tape is cut. Replace with a new tape.
- Regarding the error code "E-6" Display

When recording in time mode 120 and 168 hours or in the One-shot mode, video head clog detection is automatically carried out once for every two hours. When the video head clog is found, head cleaning is carried out for approximately 10 times. When cleaning is still not possible, "E-6" is displayed and the HED display blinks on the monitor although recording continues. In such a case, cleaning of the video heads is required.

SETTING THE RECORDING/PLAYBACK TIME

- Before performing playback/recording, it is necessary to set the desired time mode.

TIME MODE button: Recording/Playback time

PREPARATION

SP	A 2	2 H	2 H 40 M	1/60s	60.0 fields/s	Possible	Continuous
EP	A 6	6 H	8 H	1/60s	60.0 fields/s	Possible	Continuous
SP	A 12	14 H	18 H 40 M	0.12s	8.57 fields/s	Possible	Continuous
EP	A 18 (Virtual Real Time mode)	18 H	24 H	1/20s	20.0 fields/s	Possible	Continuous
SP	A 24	26 H	34 H 40 M	0.22s	4.62 fields/s	Possible	Continuous
SP	24	24 H	32 H	0.20s	5.00 fields/s	Impossible	Intermittent
SP	48	48 H	64 H	0.40s	2.50 fields/s	Impossible	Intermittent
SP	72	72 H	96 H	0.60s	1.67 fields/s	Impossible	Intermittent
SP	120	120 H	160 H	1.0s	1.00 fields/s	Impossible	Intermittent
SP	168	168 H	224 H	1.4s	0.71 fields/s	Impossible	Intermittent
SP	L01	3,600 H		60s	2 fields/1 min (*1)	Impossible	Intermittent
SP	L02	7,200 H		120s	2 fields/2 min (*1)	Impossible	Intermittent
SP	L03	10,800 H		180s	2 fields/3 min (*1)	Impossible	Intermittent

(*1): Without an alarm trigger input and an one-shot trigger input.

- The possible recording time depends on the type of video tape used.
- Audio recording is possible in the A2, A6, A12, A18 and A24 hour modes.
- The A12, A24, 24, 48, 72, 120 and 168 modes are time lapse modes.
- For one-shot recording, set the VCR in the L01, L02 or L03 record mode.
- In L01, L02 or L03 modes, the VCR is set to recording pause mode. The alarm recording starts by an alarm trigger signal input, and the VCR is set to recording pause mode again to wait for next alarm trigger input. Also the one-shot recording starts by an one-shot trigger signal input, and the VCR is set to recording pause mode again to wait for next one-shot trigger input. When recording pause mode continues for appointed time (L01: 1 min, L02: 2 min, L03: 3 min.) without an alarm trigger and an one-shot trigger input, the VCR forwards the tape 2 fields with recording to protect the tape and the video head from damage.

HOW TO OPERATE 24 HOUR VIRTUAL REAL TIME MODE

LOADING AND UNLOADING A VIDEO CASSETTE

Loading a cassette

Insert a cassette in the Cassette Compartment.

- Power goes on automatically and the cassette indicator lights.

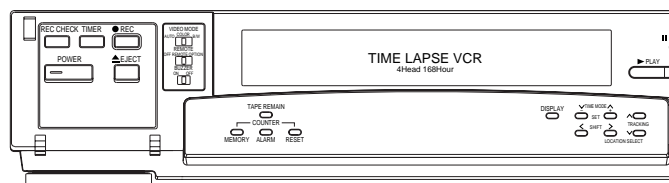

Cassette Indicator

- Blinks when inserting or removing a cassette.
- Remains lighted when a cassette is inserted even if the power is turned OFF.

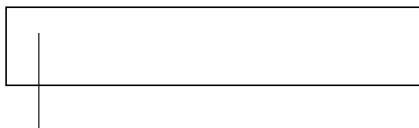

Cassette indicator

Unloading a Cassette

- Turn the power ON.

- Press the **EJECT** button.



Safety Tab

- A video cassette is equipped with a safety tab to prevent accidental erasure. When the tab is removed, recording is not possible.

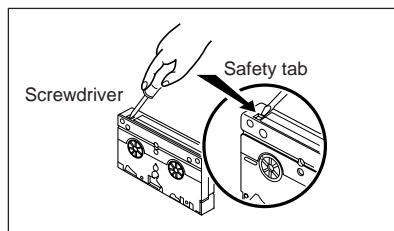

- If you wish to record on a cassette with the tab removed, use adhesive tape to cover the hole.

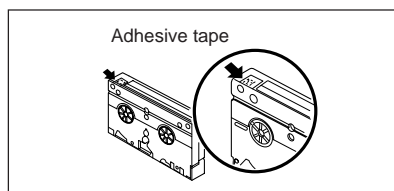

RECORDING OPERATION

RECORDING

1 Turn on the power for this VCR as well as associated devices of the surveillance system including the video camera and monitor TV.

2 Adjust the monitor TV so that the picture from the video camera is displayed properly.

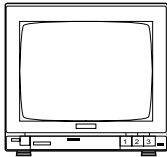

3 Check that the date time display on the monitor TV is correctly displayed.

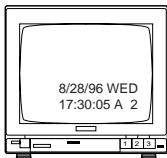

4 Set the various functions such as timer recording, alarm recording, restart recording, tape end, etc.

5 Insert a video cassette to this VCR.
• Check that the safety tab on the video cassette has not been removed.

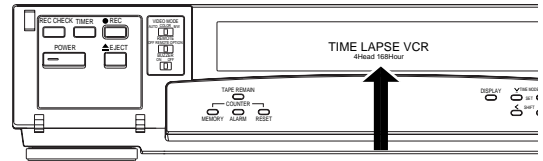

6 Select the recording time mode.



7 Press the **REC** button.



Notes:

- When the **PAUSE** button is pressed during recording, the VCR goes to the pause mode. To release, press either the **PAUSE** button again or the **REC** button. If the VCR is in pause mode for longer than 10 minutes the VCR will automatically go into stop mode to protect the video tape and heads.
- Repeat recording, restart recording, alarm recording, etc. also operate during recording.
- When recording is interrupted or the recording time is changed, the pictures may be disturbed at that location.
- If a power failure should occur, it is possible to resume recording in the same time mode as long as the power is restored within approximately 10 days.
- During repeat recording, pay attention to the following points.
 - Timer recording and alarm recording is not possible during automatic rewind.
 - The buzzer does not sound even at tape end.
 - When an operation button is pressed during automatic rewind, the repeat recording function does not operate. Reset to the recording mode.
- The time mode button is not accepted during alarm recording or timer recording.
- Make sure to carry out daily check for repeat recording or timer recording.

RESTART RECORDING

Setting the Restart Recording

On the SETUP screen set RESTART REC to ON.

- 1** Press the **DISPLAY** button. The MENU screen appears on the monitor screen.

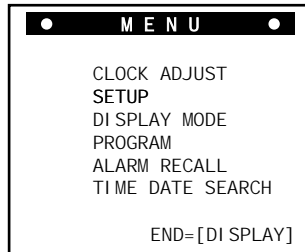
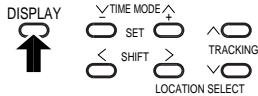

- 2** Press the **<** or **>** **SHIFT** button to blink **SETUP** and press the **+** or **-** **SET** button.

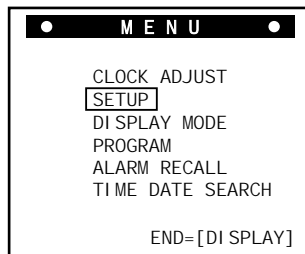
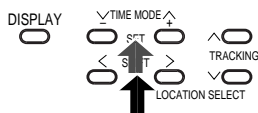

- 3** Press the **<** or **>** **SHIFT** button to blink **RESTART REC**.

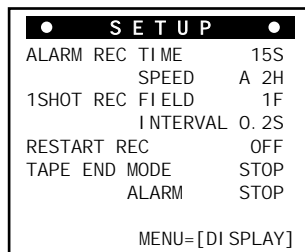
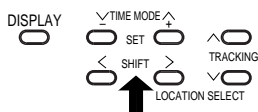

- 4** Press the **+** or **-** **SET** button to go to ON.

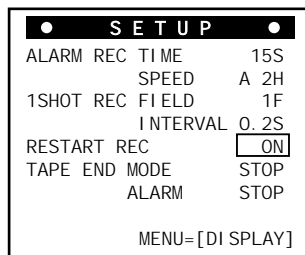
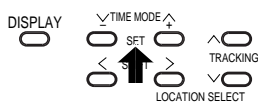

Note:

- When a power failure occurs (10 days or less in duration) during recording or timer recording, the VCR resumes automatically to the same mode when the power is restored regardless of whether "RESTART REC" is ON or OFF.
- When the power is recovered after more than 10 days have passed, the tape remains at the position where it stopped when the power failure occurred.

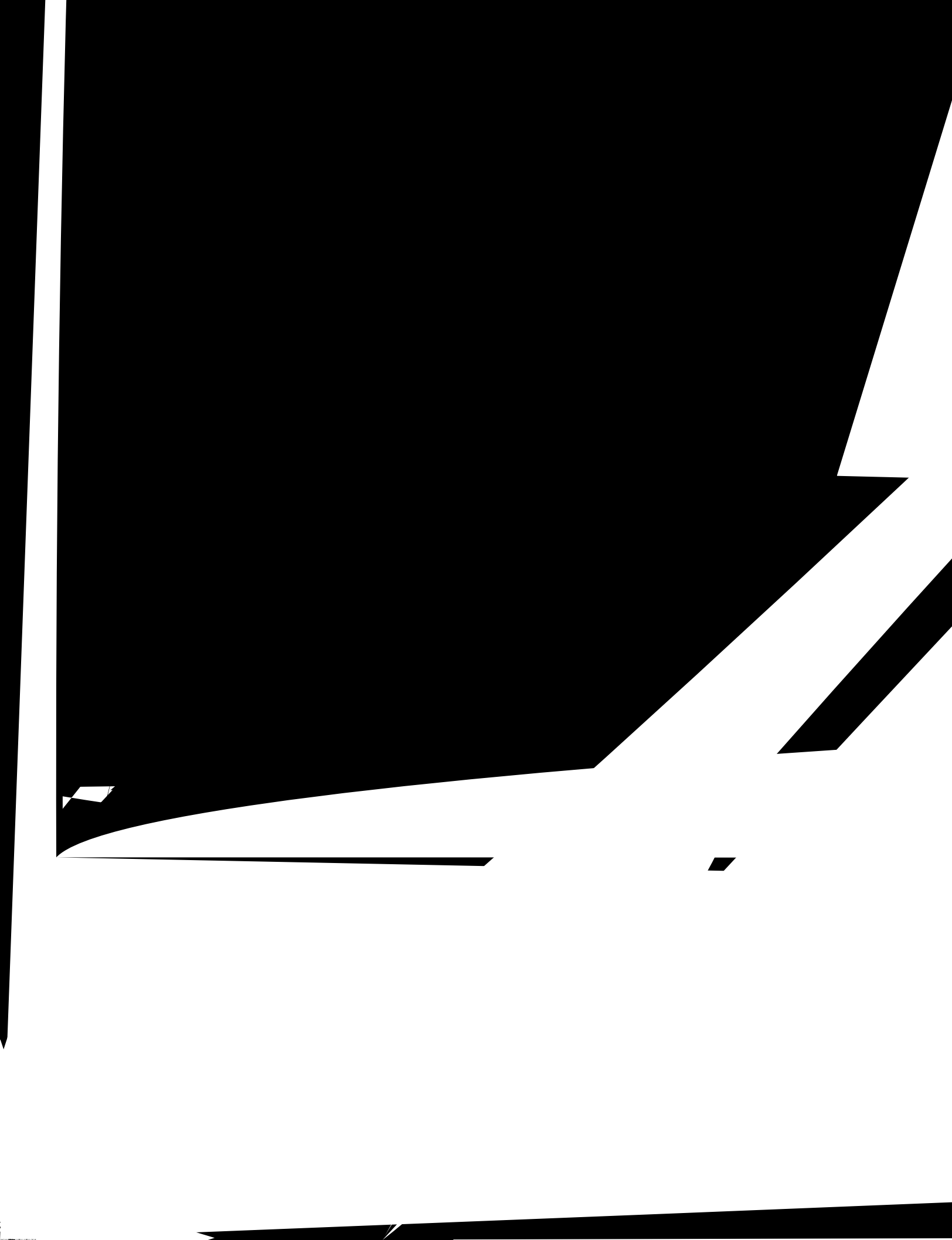

7 Press the **> SHIFT** button to blink end time. Set end time to 17:00 with the **SET** button and the **> SHIFT** button in the same manner as 6.

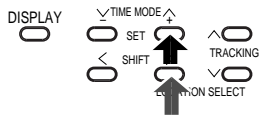

PROGRAM	
FR1 ON	--- --> --- -- 120H
FR2 ON	--- --> --- -- 120H
SA1 ON	--- --> --- -- 120H
SA2 ON	--- --> --- -- 120H
SU1 ON	--- --> --- -- 120H
SU2 ON	--- --> --- -- 120H
DLY ON	8: <u>30</u> --> --- -- 120H

MENU=[DI SPLAY]

PROGRAM	
FR1 ON	--- --> --- -- 120H
FR2 ON	--- --> --- -- 120H
SA1 ON	--- --> --- -- 120H
SA2 ON	--- --> --- -- 120H
SU1 ON	--- --> --- -- 120H
SU2 ON	--- --> --- -- 120H
DLY ON	8: 30 --> <u>17</u> : 30 120H

MENU=[DI SPLAY]

8 Press the **> SHIFT** button and the **+ SET** button to set recording time mode to A24H.

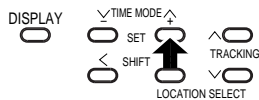

PROGRAM	
FR1 ON	--- --> --- -- 120H
FR2 ON	--- --> --- -- 120H
SA1 ON	--- --> --- -- 120H
SA2 ON	--- --> --- -- 120H
SU1 ON	--- --> --- -- 120H
SU2 ON	--- --> --- -- 120H
DLY ON	8: 30 --> 17: <u>00</u> 120H

MENU=[DI SPLAY]

PROGRAM	
FR1 ON	--- --> --- -- 120H
FR2 ON	--- --> --- -- 120H
SA1 ON	--- --> --- -- 120H
SA2 ON	--- --> --- -- 120H
SU1 ON	--- --> --- -- 120H
SU2 ON	--- --> --- -- 120H
DLY ON	8: 30 --> 17: 00 <u>120H</u>

MENU=[DI SPLAY]

- The **^ TIME MODE** button is pressed, the display changes as follows.
120H → 168H → L01 → L02 → L03 → A2 → A6 → A12 → A18 → A24 → 24 → 48 → 72 → 120
- The **v TIME MODE** button is pressed, the display changes in the reverse direction.

IF A POWER FAILURE SHOULD OCCUR

- If a power failure occurs, the PW.FAIL display appears in the VCR display. To erase this display press one of the operations buttons.
- If the power failure is recovered within 10 days, and the battery is charged continuously for more than 48 hours in the ambient temperature, the date/time data and timer recording programs remain in the memory.

9 Press the **DISPLAY** button twice to erase the MENU screen.

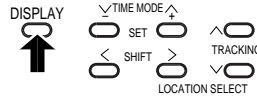

8/28/96 WED	
17: 30: 02 A 2	

10 Press the **TIMER** button.



REC 1234 TIMER SP A24 H	
-------------------------	--

- The power goes off and the **TIMER** display lights in the VCR display.
- Recording starts at the programmed start time.

Notes:

- If the **TIMER** button is pressed at the moment between start time and end time, recording starts immediately.
- To cancel the timer recording, press the **POWER** button or the **TIMER** button.
- The time difference between start time and end time should be more than 1 minute. If they are same, timer recording doesn't work.
- The accuracy of the time display depends on the conditions of use and the environment. Set clock to the exact time by daily check.
- During timer power off mode, alarm recording will not operate at all.

During the 12 hour display, the display appears as follows.

PROGRAM	
FR1 ON	-: --- --> -: --- -- 120H
FR2 ON	-: --- --> -: --- -- 120H
SA1 ON	-: --- --> -: --- -- 120H
SA2 ON	-: --- --> -: --- -- 120H
SU1 ON	-: --- --> -: --- -- 120H
SU2 ON	-: --- --> -: --- -- 120H
DLY ON	-: --- --> -: --- -- 120H

MENU=[DI SPLAY]

Weekly Timer Recording

To record every week for certain period on a certain day of the week, set the weekly timer recording. With the weekly timer recording, 2 programs are possible for each day of the week.

In case of setting A18 from 8:00 to 19:00 on all weekdays, and A18 from 9:00 to 17:00 on Saturday and Sunday.

1 Press the **DISPLAY** button.

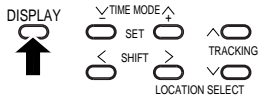

MENU	
CLOCK ADJUST	
SETUP	
DI SPLAY MODE	
PROGRAM	
ALARM RECALL	
TIME DATE SEARCH	
END=[DI SPLAY]	

5 Press the **+ SET** button to set the starting hour to 8 and press the **>** **SHIFT** button.

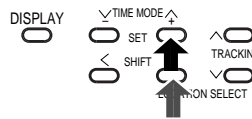

PROGRAM	
MO1 ON [8] 15 → --- 120H	
MO2 ON --- -- -- -- 120H	
TU1 ON --- -- -- -- 120H	
TU2 ON --- -- -- -- 120H	
WE1 ON --- -- -- -- 120H	
WE2 ON --- -- -- -- 120H	
TH1 ON --- -- -- -- 120H	
TH2 ON --- -- -- -- 120H	
MENU=[DI SPLAY]	

2 Press the **>** **SHIFT** button to blink **PROGRAM**.

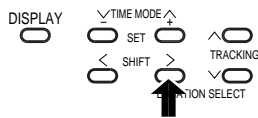

MENU	
CLOCK ADJUST	
SETUP	
DI SPLAY MODE	
PROGRAM	
ALARM RECALL	
TIME DATE SEARCH	
END=[DI SPLAY]	

6 Press the **+ SET** button to set the starting minute to 00 and press the **>** **SHIFT** button.

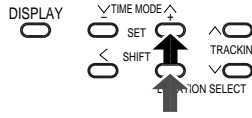

PROGRAM	
MO1 ON 8: [00] → --- 120H	
MO2 ON --- -- -- -- 120H	
TU1 ON --- -- -- -- 120H	
TU2 ON --- -- -- -- 120H	
WE1 ON --- -- -- -- 120H	
WE2 ON --- -- -- -- 120H	
TH1 ON --- -- -- -- 120H	
TH2 ON --- -- -- -- 120H	
MENU=[DI SPLAY]	

3 Press the **+ SET** button.

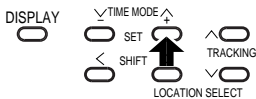

PROGRAM	
MO1 ON [ON] --- -- -- -- 120H	
MO2 ON --- -- -- -- 120H	
TU1 ON --- -- -- -- 120H	
TU2 ON --- -- -- -- 120H	
WE1 ON --- -- -- -- 120H	
WE2 ON --- -- -- -- 120H	
TH1 ON --- -- -- -- 120H	
TH2 ON --- -- -- -- 120H	
MENU=[DI SPLAY]	

7 Press the **+ SET** button to set the ending hour to 19 and press the **>** **SHIFT** button.

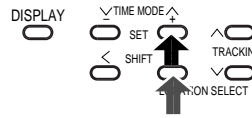

PROGRAM	
MO1 ON 8: 00 → [19] 00 120H	
MO2 ON --- -- -- -- 120H	
TU1 ON --- -- -- -- 120H	
TU2 ON --- -- -- -- 120H	
WE1 ON --- -- -- -- 120H	
WE2 ON --- -- -- -- 120H	
TH1 ON --- -- -- -- 120H	
TH2 ON --- -- -- -- 120H	
MENU=[DI SPLAY]	

4 Press the **>** **SHIFT** button to blink the **MO1** start time.

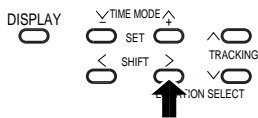

PROGRAM	
MO1 ON [--] --- -- -- -- 120H	
MO2 ON --- -- -- -- 120H	
TU1 ON --- -- -- -- 120H	
TU2 ON --- -- -- -- 120H	
WE1 ON --- -- -- -- 120H	
WE2 ON --- -- -- -- 120H	
TH1 ON --- -- -- -- 120H	
TH2 ON --- -- -- -- 120H	
MENU=[DI SPLAY]	

8 Press the **+ SET** button to set the ending minute to 00 and press the **>** **SHIFT** button.

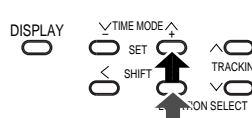

PROGRAM	
MO1 ON 8: 00 → 19: [00] 120H	
MO2 ON --- -- -- -- 120H	
TU1 ON --- -- -- -- 120H	
TU2 ON --- -- -- -- 120H	
WE1 ON --- -- -- -- 120H	
WE2 ON --- -- -- -- 120H	
TH1 ON --- -- -- -- 120H	
TH2 ON --- -- -- -- 120H	
MENU=[DI SPLAY]	

9 Press the + **SET** button to set to A18.

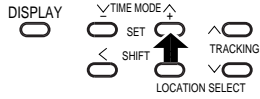

PROGRAM			
MO1 ON	8: 00 → 19: 00	A18H	
MO2 ON	--: -- → --: --	--: --	120H
TU1 ON	--: -- → --: --	--: --	120H
TU2 ON	--: -- → --: --	--: --	120H
WE1 ON	--: -- → --: --	--: --	120H
WE2 ON	--: -- → --: --	--: --	120H
TH1 ON	--: -- → --: --	--: --	120H
TH2 ON	--: -- → --: --	--: --	120H
MENU=[DI SPLAY]			

13 Following the same procedures as steps from 4 to 10, set FR1, SA1 and SU1.

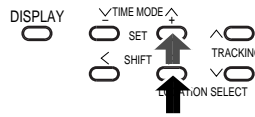

PROGRAM			
FR1 ON	8: 00 → 19: 00	A18H	
FR2 ON	--: -- → --: --	--: --	120H
SA1 ON	9: 00 → 17: 00	A18H	
SA2 ON	--: -- → --: --	--: --	120H
SU1 ON	9: 00 → 17: 00	A18H	
SU2 ON	--: -- → --: --	--: --	120H
DLY ON	8: 30 → 17: 00	A24H	
MENU=[DI SPLAY]			

10 Press the > **SHIFT** button twice to blink the TU1 start time. Repeat steps from 5 to 9.

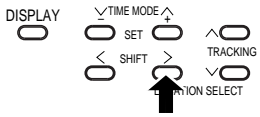

PROGRAM			
MO1 ON	8: 00 → 19: 00	A18H	
MO2 ON	--: -- → --: --	--: --	120H
TU1 ON	8: -- → --: --	--: --	120H
TU2 ON	--: -- → --: --	--: --	120H
WE1 ON	--: -- → --: --	--: --	120H
WE2 ON	--: -- → --: --	--: --	120H
TH1 ON	--: -- → --: --	--: --	120H
TH2 ON	--: -- → --: --	--: --	120H
MENU=[DI SPLAY]			

14 Press the > **SHIFT** button to blink the ON of DLY. Press the + **SET** button to set to SKIP if you don't need daily timer recording.

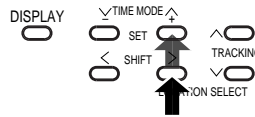

PROGRAM			
FR1 ON	8: 00 → 19: 00	A18H	
FR2 ON	--: -- → --: --	--: --	120H
SA1 ON	9: 00 → 17: 00	A18H	
SA2 ON	--: -- → --: --	--: --	120H
SU1 ON	9: 00 → 17: 00	A18H	
SU2 ON	--: -- → --: --	--: --	120H
DLY SKI P8:	30 → 17: 00	A24H	
MENU=[DI SPLAY]			

11 Set to WE1 and TH1 following the steps from 4 to 10.

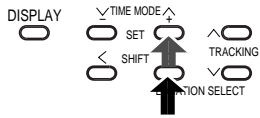

PROGRAM			
MO1 ON	8: 00 → 19: 00	A18H	
MO2 ON	--: -- → --: --	--: --	120H
TU1 ON	8: 00 → 19: 00	A18H	
TU2 ON	--: -- → --: --	--: --	120H
WE1 ON	8: 00 → 19: 00	A18H	
WE2 ON	--: -- → --: --	--: --	120H
TH1 ON	8: 00 → 19: 00	A18H	
TH2 ON	--: -- → --: --	--: --	120H
MENU=[DI SPLAY]			

15 Press the **DISPLAY** button twice.

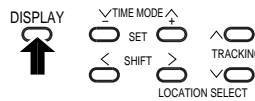

8/28/96 WED	
17: 30: 02 A 2	

12 When TH2 ending minute blinks, press the > **SHIFT** button. The screen changes to the next screen.

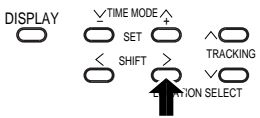

PROGRAM			
FR1 ON	--: -- → --: --	--: --	120H
FR2 ON	--: -- → --: --	--: --	120H
SA1 ON	--: -- → --: --	--: --	120H
SA2 ON	--: -- → --: --	--: --	120H
SU1 ON	--: -- → --: --	--: --	120H
SU2 ON	--: -- → --: --	--: --	120H
DLY ON	8: 30 → 17: 00	A24H	
MENU=[DI SPLAY]			

16 Press the **TIMER** button.



REC	1234	SP	A24
	TIMER		

Overlapping Programs

- When the setting times 1 and 2 for the day of the week and the daily times overlap, recording will be carried out as shown below.

Example:

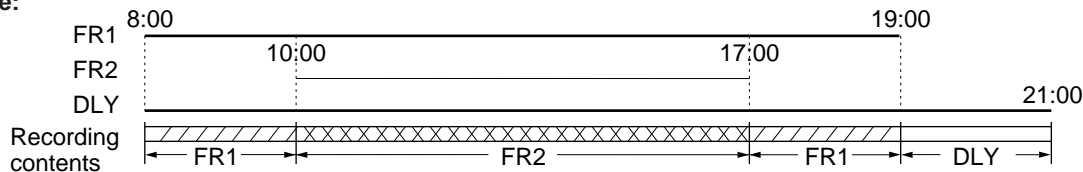

- If the timer recording button is pressed after 10:00, FR1 is recorded and FR2 is not implemented. (The order of priority for recordings in case of overlapping is FR1, FR2, DLY).

ALARM RECORDING

If an alarm condition arises, the alarm function operates with an alarm input signal.

Operation at Alarm Input

When there is an alarm during recording, recording pause or stop modes, the VCR automatically goes into alarm recording mode. The VCR can be programmed to record in the following time modes during alarm recording: A2, A6, A12, A18, A24.

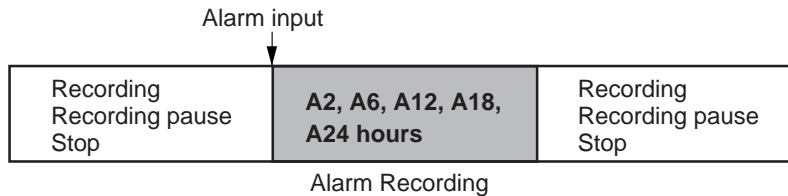

- When there is an alarm input in the STOP mode, a slight delay will occur in start of the alarm recording.
- When the pause mode continues for 10 minutes the VCR goes to the stop mode. This occurs in order to protect the video heads and tape. While in pause mode, the video head is constantly tracing the same location.
- Alarm recording will not operate from power off mode and timer power off mode.

Event Recording

If event recording is desired, set the VCR's recording mode to L01, L02 or L03. In order to accomplish this press the time mode button until "L01", "L02" or "L03" is shown.

If there is no alarm input present when in "L01", "L02" or "L03" mode, the VCR automatically forwards 2 fields with recording every appointed time (L01: 1min, L02: 2min, L03: 3min.) to protect the tape and the video head from damage.

Warning at Alarm Recording

When an alarm signal is input, the buzzer sounds and the alarm display on the VCR DISPLAY lights.

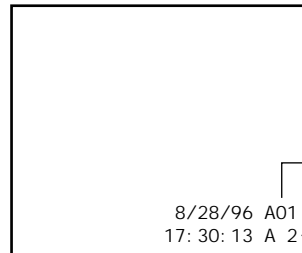
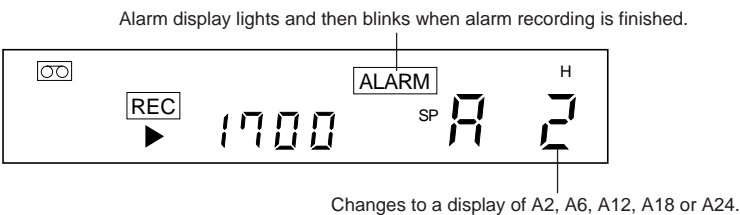

- Turn off the BUZZER switch to stop the buzzer.
- To stop the alarm display blinking, press the **ALARM** button to change the counter display to the alarm counter and then press the **RESET** button.

Alarm Recall Display

Check the alarm input information on the ALARM RECALL screen.

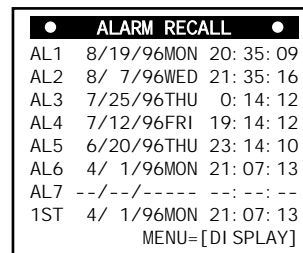
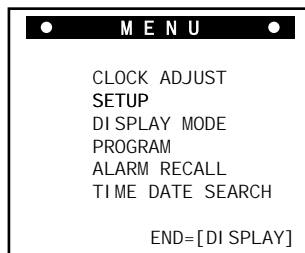

- At 1ST, the first (oldest) alarm input information is displayed.
- At AL1, the latest alarm input information is displayed.
- When more than seven items are input, the old information is erased and the new information is stored in the memory.
- To erase the alarm recall contents, press the **ALARM** button to change the counter display to alarm counter and press the **RESET** button.

Connecting the Alarm Terminals

■ Connecting the ALARM IN/OUT terminals

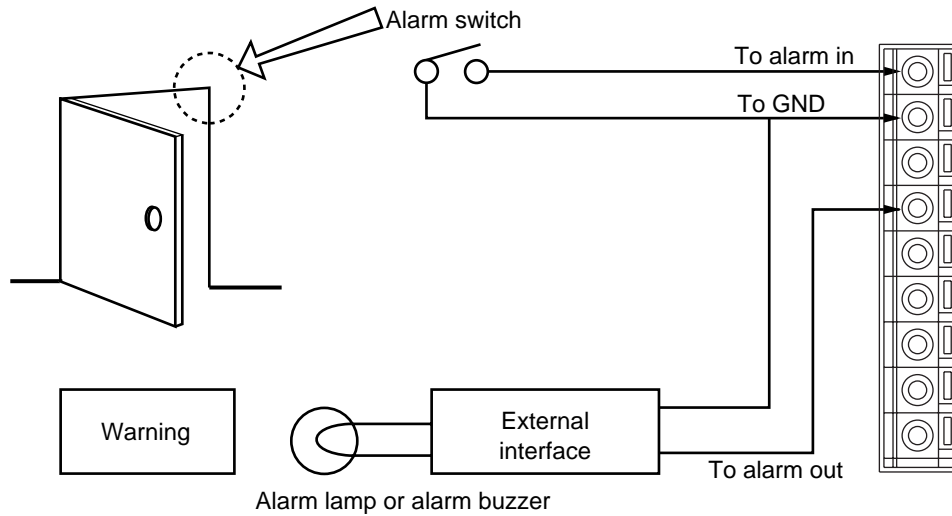

- When the alarm switch is ON, alarm recording starts. It is possible to confirm the warning from outside by connecting the switching input of external interface devices such as alarm lamp or alarm buzzer to the alarm output. Please do not use the alarm output for power source to any of external devices.

■ Connecting alarm reset input

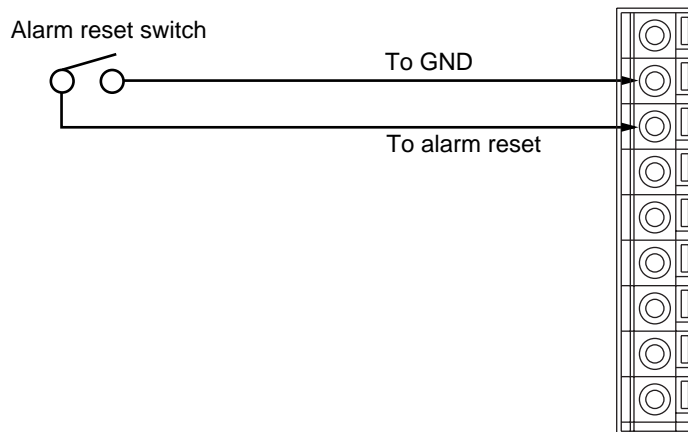

- When the alarm switch is ON, alarm recording starts. However, when a closure is applied across the ALARM RESET and GND terminals, the alarm record condition resets and the VCR returns to the original record mode it was in before the alarm condition occurred.

Note:

- When simultaneously connecting alarm input and alarm reset input, be sure to carefully check the voltage levels.

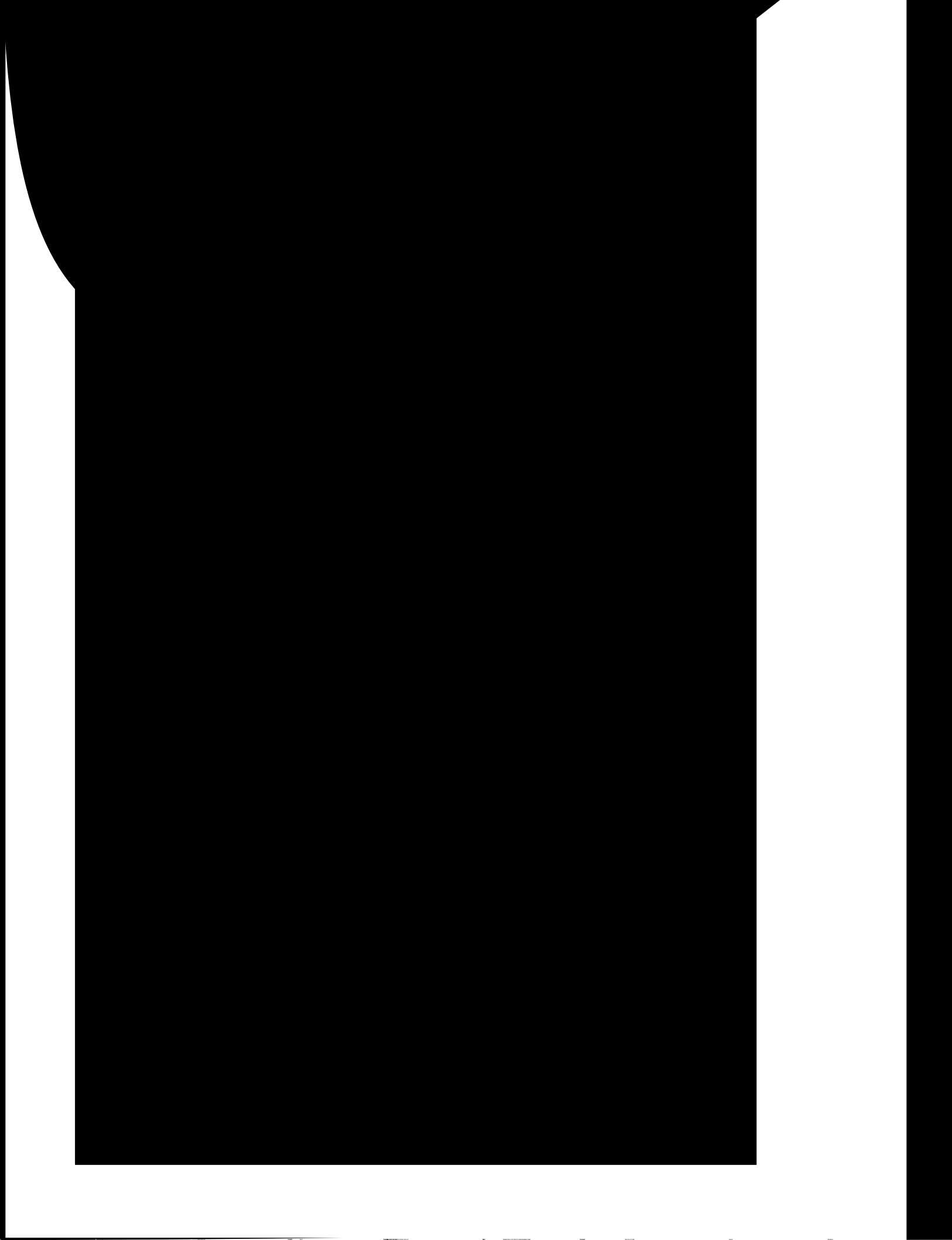

ONE-SHOT RECORDING

It is possible with this VCR to carry out one-shot recording to record only when there is a trigger input from outside or for use as a data file. If a trigger is input to the one-shot input on the back, there will be recording for the field numbers set at the time interval set.

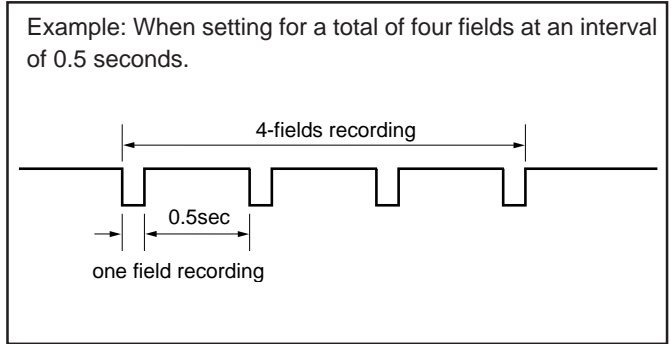
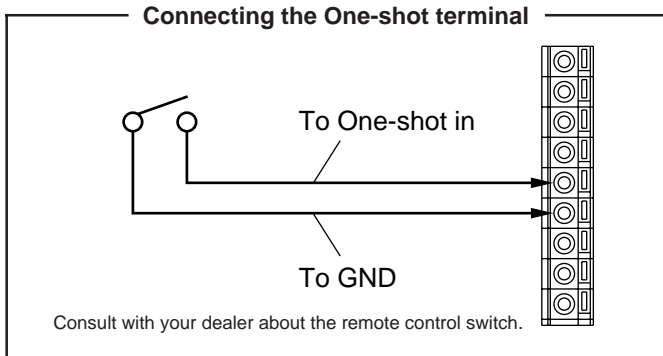

Operation of One-shot Recording

1 Press the **^ TIME MODE** button to select L01, L02 or L03.

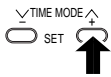

2 Press the **DISPLAY** button.

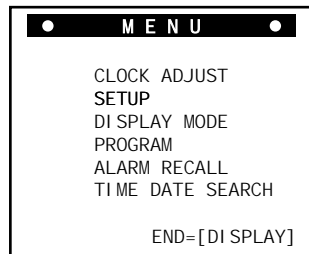
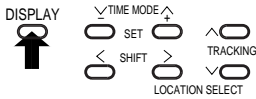

3 Press the **> SHIFT** button to make **SETUP** blink and press the **+ SET** button.

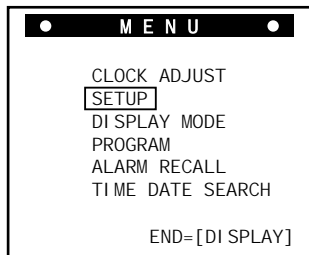
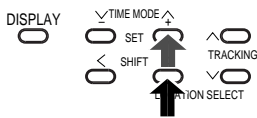

4 Press the **> SHIFT** button to make 1 SHOT REC FIELD blink and press the **+ SET** button to set the number of recording fields.

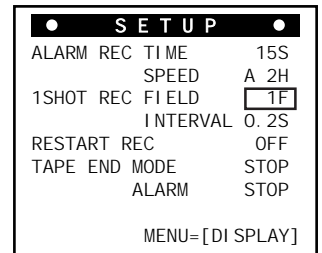
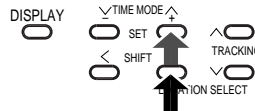

- Each time pressing the **+ SET** button the display changes as follows.
1F → 2F → 4F → 8F → 16F → 32F → MANUAL
- Each time pressing the **- SET** button, the display changes in the reverse direction.

Display	Recording fields
1F	1 field
2F	2 fields
4F	4 fields
8F	8 fields
16F	16fields
32F	32 fields
MANUAL	Accepting the one-shot input.

Note:

- Because the head is constantly tracing the same location, it can cause damage to the head and tape. For this reason, if there is no one-shot input when the time mode is set to L01, L02 or L03 the VCR automatically records 2 fields every 1, 2 or 3 minutes to protect the tape and heads. Choose the time mode suited to your particular purpose.

5 Press the **> SHIFT** button to make INTERVAL blink.
Press the **+ SET** button to set the time interval between the individual recording fields.

SETUP		
ALARM REC TIME		15S
SPEED		A 2H
1SHOT REC FIELD		1F
INTERVAL		0.2S
RESTART REC		OFF
TAPE END MODE		STOP
ALARM		STOP
MENU=[DI SPLAY]		

- Each time pressing the **+ SET** button, the display changes as follows.
0.2s → 0.5s → 1.0s → 2.0s
- Each time pressing the **- SET** button, the display changes in the reverse order.

Display	Time interval
0.2s	1 field per 0.2 seconds
0.5s	1 field per 0.5 seconds
1.0s	1 field per 1.0 seconds
2.0s	1 field per 2.0 seconds

6 Press the **DISPLAY** button twice to erase the display.

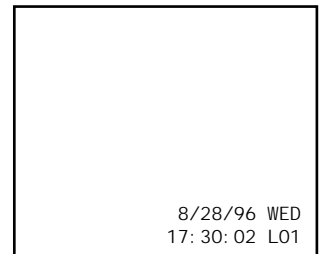
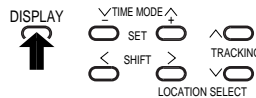

7 Press the **REC** button.



8 Input from the remote control switch.

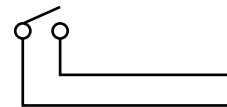

Remote control switch

To release the One-shot Recording mode

Press the **∨** or **∧** **TIME MODE** button to change the time display on the VCR display to a display other than L01, L02 and L03.

Note:

- One-shot input is not accepted during recording pause.

OPERATION AFTER TAPE END DETECTION

The VCR can be programmed to respond differently when the tape reaches its end. The following describes how to set the different modes of operation.

How to Set to Stop at End of Tape

1 Press the **DISPLAY** button.

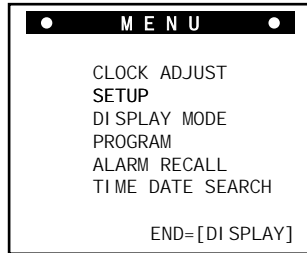
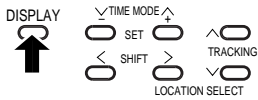

2 Press the **<** or **>** **SHIFT** button to blink **SETUP** and press the **+** **SET** button.

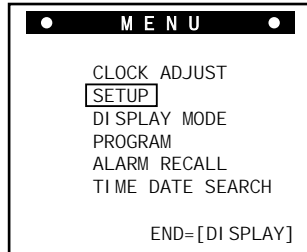
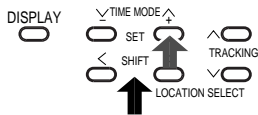

3 Press the **<** or **>** **SHIFT** button to blink **TAPE END MODE**.

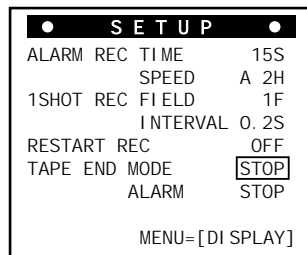
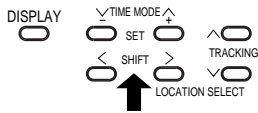

4 Press the **+** or **-** **SET** button to set the operation after tape end detection.

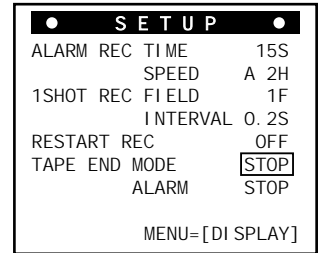
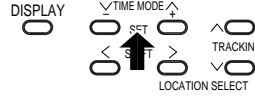

- Each time the **+** **SET** button is pressed, the display changes as follows.
STOP → (REW → STOP) → (REW → REC)
- Each time the **-** **SET** button is pressed, the display changes in the reverse order.

Display	Operation after detection of tape end
STOP	Stops at tape end.
REW → STOP	Rewinds to beginning of tape and stops.
REW → REC	Set to carry out repeat recording. Rewinds to beginning of tape and records.

Caution:

If you need Auto Rewind function even for the case that alarm recording starts during recording, please set TAPE END ALARM to "CONT." in the MENU SCREEN.

Note:

- The buzzer, screen display and counter displays operate as follows depending on the setting for operations after tape end detection.

Setting contents	Buzzer	Screen display	Counter display
STOP	Buzzer sounds at tape end	TAPE END blinks	Counter display blinks
REW → STOP	Buzzer sounds at tape top	TAPE END blinks	Counter display blinks
REW → REC			

The VCR can be programmed to automatically rewind the tape when the tape reaches its end.

How to Set to Auto Rewind at End of Tape

1 Press the **DISPLAY** button.

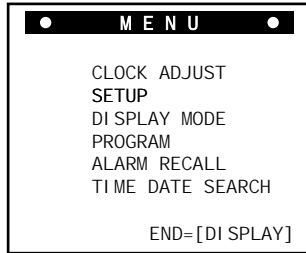
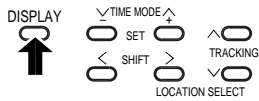

4 Press the + or - **SET** button to select REW → STOP.

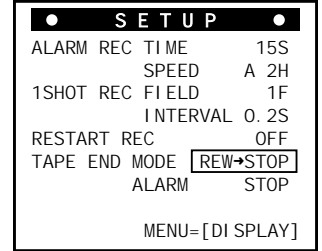
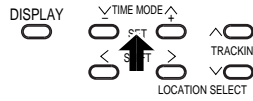

2 Press the < or > **SHIFT** button to blink SETUP and press the + **SET** button.

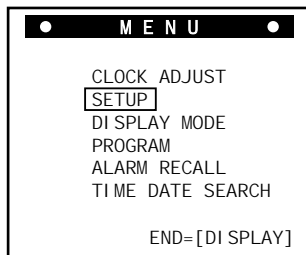
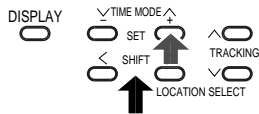

5 Press the **DISPLAY** button twice to erase the display.

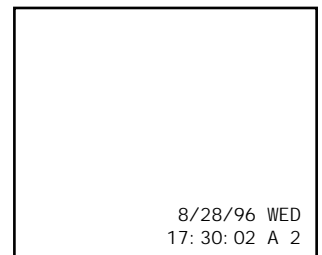
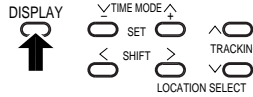

3 Press the < or > **SHIFT** button to blink TAPE END MODE.

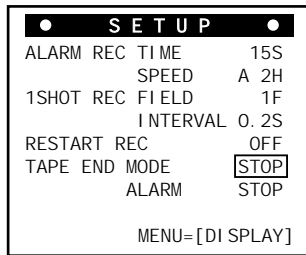
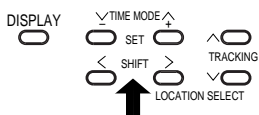

- When tape end is detected during recording, the tape automatically rewinds and stops at beginning of the tape.

Caution:

If you need the VCR to Auto Rewind even if an alarm condition occurred then set TAPE END ALARM to "CONT." in the MENU SCREEN.

Note:

- Alarm recording does not operate during auto-rewind.

The VCR can be programmed to automatically restart recording when the tape reaches its end. With this function, the VCR will automatically rewind the tape and begin recording.

How to Set to Repeat Record at End of Tape

1 Press the **DISPLAY** button.

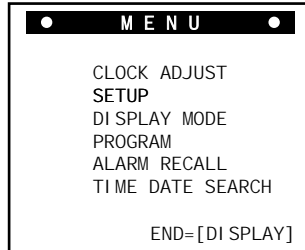
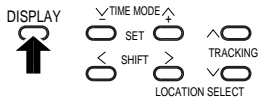

2 Press the **<** or **>** **SHIFT** button to blink **SETUP** and press the **+** **SET** button.

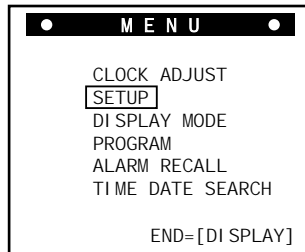
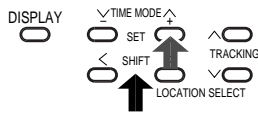

3 Press the **<** or **>** **SHIFT** button to blink **TAPE END MODE**.

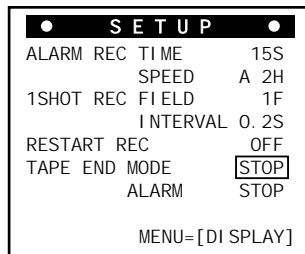
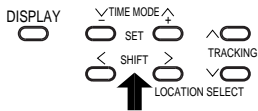

4 Press the **+** or **-** **SET** button to select **REW** → **REC.**

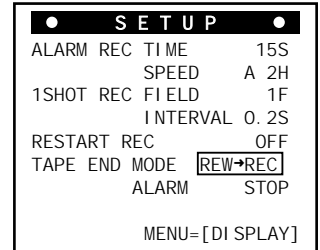
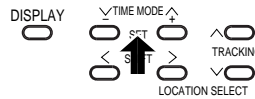

■ Now the Repeat Recording Setting is completed.

5 Press the **DISPLAY** button twice to erase the display.

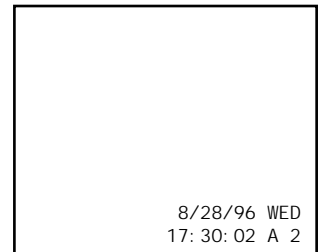
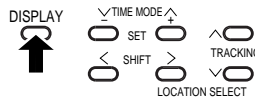

■ When tape end is detected during recording, the VCR automatically rewinds the tape and goes to recording mode at beginning of the tape.

Caution:

If you need the VCR to repeat record even if an alarm condition occurred then set TAPE END ALARM to "CONT." in the MENU SCREEN.

Notes:

- When the VCR is working in repeat recording, make sure to carry out daily checks.
- Alarm recording does not operate during auto-rewind.

RECORDING WITH THE SEQUENTIAL SWITCHER

This VCR can work with a sequential switcher connected for recording.

Connection with the Sequential Switcher

For detailed operations and connections of the switcher, consult the Instruction Manual of the sequential switcher.

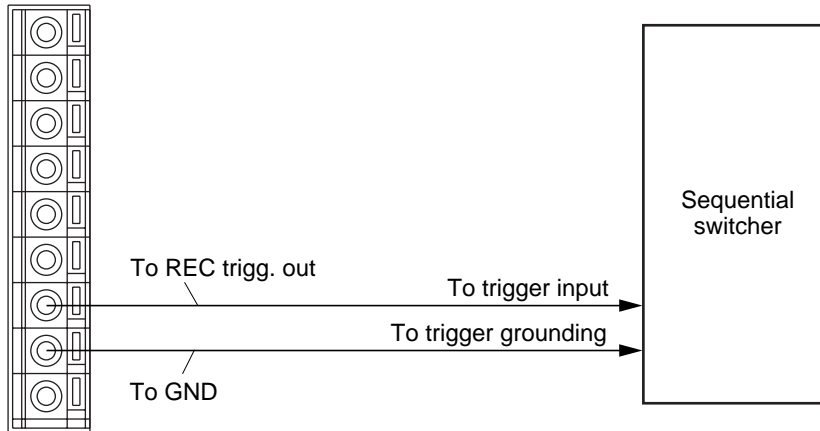

Timing for Camera Switching

In case of using the sequential switcher for 4 channels (and recording for A18 hours);

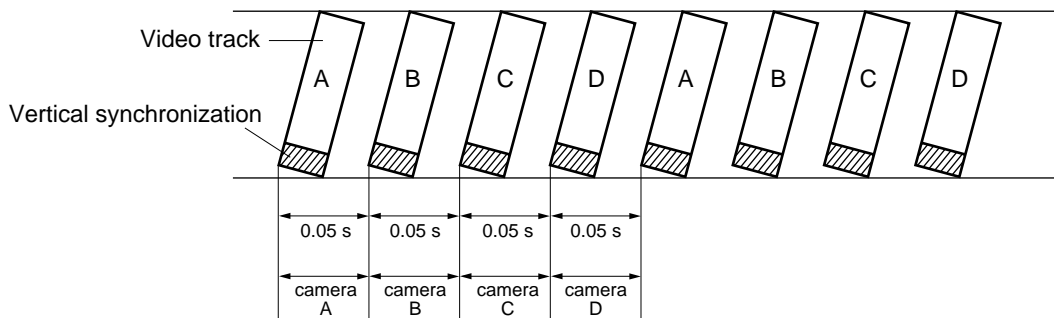

Notes:

- Each time a video track is recorded, the video camera is automatically switched by the position of the vertical synchronization signal.
- The video camera switching time differs according to the time mode.
- Record/playback picture is snowy or noisy when operating with a B/W multiplex or B/W quad, please select the VIDEO MODE switch to B/W mode. (See page 5.)
- In A18 record mode, quick response switcher is necessary.

REC Trigger Output Selection in the Alarm Recording

REC Trigger output can be selected during the alarm recording.

1 Press the **DISPLAY** button.

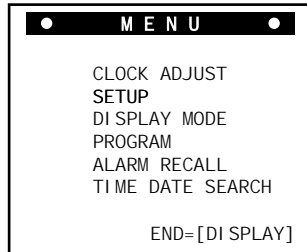
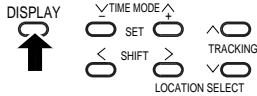

2 Press the **> SHIFT** button to blink **SETUP**.

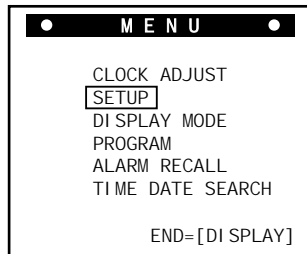
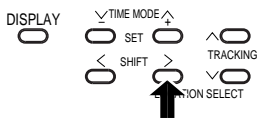

3 Press the **+ SET** button.

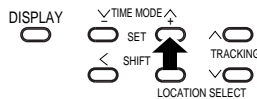

■ Change to SETUP Screen (1).

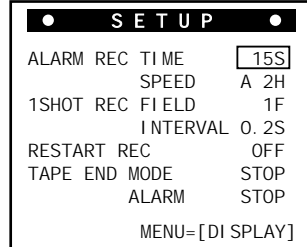

4 Press the **< SHIFT** button. And press the **+ SET** button to set the REC trigger SEL.

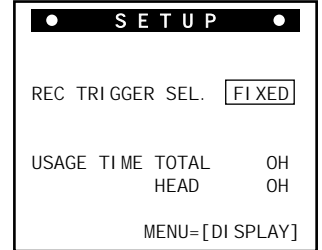
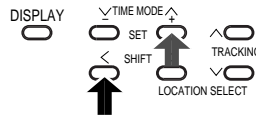

■ Each time the **+ SET** button is pressed, the display changes as follows.

→FIXED → PULSE→

5 Press the **DISPLAY** button twice to erase the display.

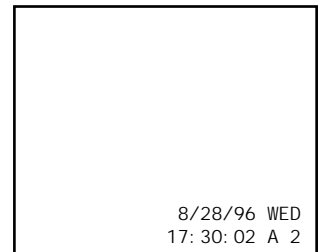
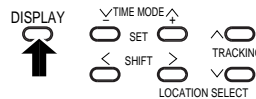

REC TRIGGER SEL.	Normal Recording		Alarm Recording		One shot Recording
	A2, A6	A12 ~ 168	A2, A6	A12 ~ A24	L01 ~ L03
FIXED	LOW (0V)	PULSE (*1)	HIGH (5V)	HIGH (5V)	PULSE (*1)
PULSE	PULSE (*1)	PULSE (*1)	PULSE (*1)	PULSE (*1)	PULSE (*1)

PULSE (*1) detail

	Record mode						
		A2	A6	A12	A18	A24	24
	a (ms)	20	20	32	32	32	32
	b (ms)	32 ~ 36	32 ~ 36	116 ~ 120	48 ~ 52	216 ~ 220	180 ~ 220
	Record mode						
		48	72	120	168	L01 ~ L03	
a (ms)	32	32	32	32	32		
b (ms)	380 ~ 420	580 ~ 620	980 ~ 1020	1380 ~ 1420	Depend on the condition		

PLAYBACK OPERATION

PLAYBACK

- 1** Turn the power ON for the monitor TV.

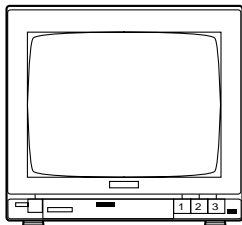

- 3** Press the **PLAY** button.

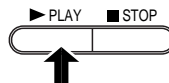

- 2** Insert a tape which has been recorded on.

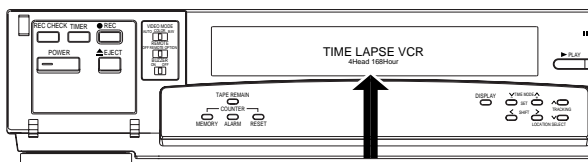

- 4** Select the playback time mode.

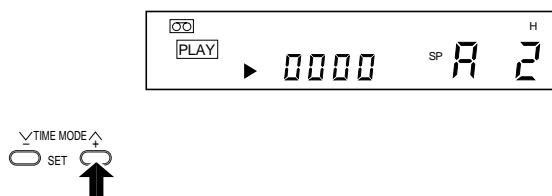

Tracking Adjustment

Use the ∇ , \blacktriangle **TRACKING** button to adjust when noise appears on the playback screen.



- Press either ∇ or \blacktriangle **TRACKING** button so that a clearer picture is obtained.
- When returning the tracking to a standard adjustment value, press \blacktriangle and ∇ buttons simultaneously.

Notes:

- When restart record is selected, and a power failure occurs, the VCR will automatically go into record mode when power is restored.
- When the **PAUSE** button is pressed during playback, the VCR will go into still mode. To return to playback, press the **PAUSE** or **PLAY** button. If the VCR is in still mode for longer 10 minutes the VCR will automatically resume normal playback.
- Reverse playback is released after 1 minute and the VCR returns to normal playback.
- The time mode cannot be changed during reverse playback (only in A2- and A6-hours).
- When playing back a tape that has been recorded in the A12, A18, A24, 24, 48, 72, 120 and 168 hour modes, pay attention to the following points.
 - The picture may be somewhat horizontally unstable however, this is not a malfunction of the VCR.
 - The upper section of the picture on the monitor screen may be distorted. This is not an abnormality.
- When playing back tapes recorded in various time modes, the picture may be slightly unstable depending on the time mode.

Recording time mode	Time mode for playback
A2, A12, A24, 24, 48, 72, 120, 168, L01, L02, L03 hour	A2, A12, A24, 24, 48, 72, 120, 168 hour
A6, A18 hours	A6, A18 hours

- The picture may be vertically unstable during playback in the A12, A18, A24, 24, 48, 72, 120 and 168 hour modes. This is not an abnormality.
- When returning to normal playback after picture search, the picture may wobble for a short while.

Using the SHUTTLE Dial

You can also activate the picture search and slow playback of various speed by turning the shuttle dial on the VCR.

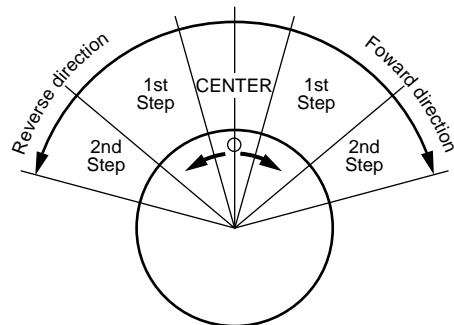
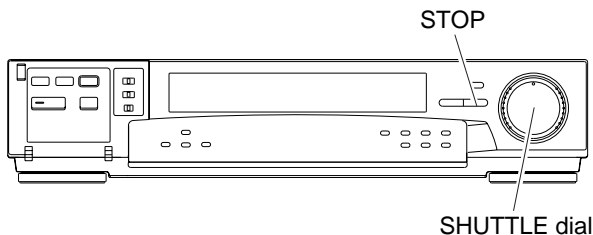

The playback speed changes by turning the dial as shown below:

Turn dial to the Reverse direction				Dial CENTER	Turn dial to the Forward direction			
2nd STEP	Return to center	1st STEP	Return to center		1st STEP	Return to center	2nd STEP	Return to center
REW	REW	REW	REW	STOP	FF	FF	FF	FF
Reverse PICTURE SEARCH (SP: -x 5) (EP: -x 15)	PLAY	Reverse PLAY (-x 1)	PLAY	PLAY	Forward PICTURE SEARCH (SP: x5) (EP: x 15)	PLAY	Forward PICTURE SEARCH (SP: x5) (EP: x 15)	PLAY
Reverse SLOW PLAY (-x 1/30)	Reverse SLOW PLAY (-x 1/30)	Reverse SLOW PLAY (-x 1/30)	STILL	STILL	Forward SLOW PLAY (x 1/30)	STILL	Forward SLOW PLAY (x 1/30)	Forward SLOW PLAY (x 1/30)

If you release the dial, it turns to the center position.

Notes:

- As the **SHUTTLE** dial is turned in the stop mode, the VCR is set to the FF or REW mode and it does not go back to stop mode until you press the **STOP** button. Turning the dial back to initial position does not return the VCR to the stop mode.
- The reverse playback mode will be released automatically after 1 minute and the forward playback will start.
- The still picture mode will be released automatically after 10 minutes and forward playback will start.
- The reverse slow mode will be playback up to 255 fields.

PLAYBACK IN VARIOUS MODES

The following operations are possible during playback.

Picture Search

It is possible to carry out fast forward and rewind while viewing picture and thus quickly locate the section you wish to view (image played back at speed of 5 times faster than A2 mode).

Turn the **SHUTTLE** dial all the way to the left or right during playback. (See page 40.)

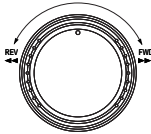

To return to playback, release the **SHUTTLE** dial.

Slow Playback

Used for creating a clear playback in the time-lapse mode of a RECORDED TAPE.

Press the **TIME MODE** button during playback to set to one of the times. (See page 39.)

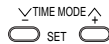

To return to normal playback, press the button to set to A2 or A6 hours.

Reverse Playback

Used to carry out reverse playback of recorded tapes. Turn the **SHUTTLE** dial to the reverse direction during playback. (See page 40.)

To return to playback, release the **SHUTTLE** dial.

- When reverse playback continues for one minute, the unit automatically returns to playback.

Notes:

If the screen waves up and down during still playback;

- Press the **TRACKING** button in a still playback to adjust the picture so that the screen waving stops.



Still Playback

Used to take a photograph, for example, of a particular scene. Press the **PAUSE** button during playback.

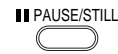

To return to playback, press either the **PAUSE** button or the **PLAY** button.

- If still playback continues for ten minutes, the unit automatically returns to playback.

Field Advance Playback

Used when you want to analyze a scene in more details during playback.

Turn the **SHUTTLE** dial to the forward direction during still playback.

To return to still playback, release the **SHUTTLE** dial. (See page 40.)

- If the **SHUTTLE** dial is turned to end, a field advance playback is continuously carried out.

To return to still playback, press the **PAUSE** button.

Reverse Field Advance Playback

Used when you want to analyze a scene in more detail during playback.

Turn the **SHUTTLE** dial to the reverse direction during still playback.

To return to still playback, release the **SHUTTLE** dial. (See page 40.)

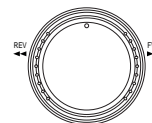

- If the **SHUTTLE** dial is turned to end, a reverse field advance playback is continuously carried out.

To return to still playback, press the **PAUSE** button.

- The reverse field advance is allowed up to 255 fields.

If noise occurs during slow playback or still playback;

- Set the slow (field advance) playback mode and press the **TRACKING** button to adjust the tracking. There may still be some residue of noise even after tracking adjustment.

TIME DATE SEARCH

Searching a picture at a desired day and time is possible by specifying the day and hour on the MENU screen. The VCR automatically records the current date and time (day/hour/minute). Accordingly, make sure before recording that the date and time is exactly adjusted.

Search Operation

In case of searching the picture at day of 28, 17:30 minutes in reverse direction;

1 Press the **DISPLAY** button.

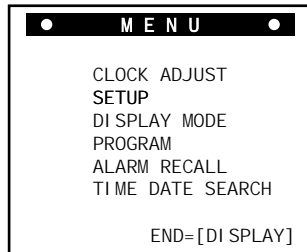
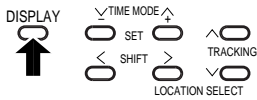

4 Press the **SET** button to set the HOUR to 17 and press the **> SHIFT** button.

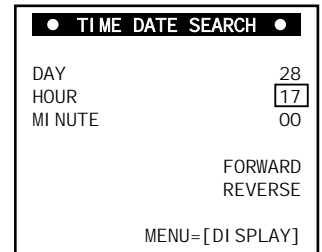
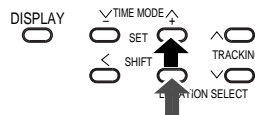

2 Press the **SHIFT** button to blink TIME DATE SEARCH and press the **SET** button.

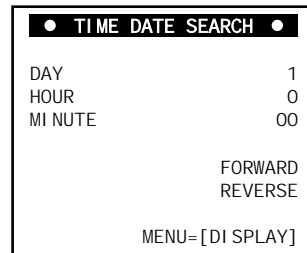
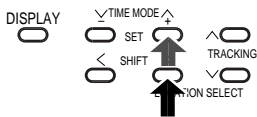

5 Press the **SET** button to set the MINUTE to 30.

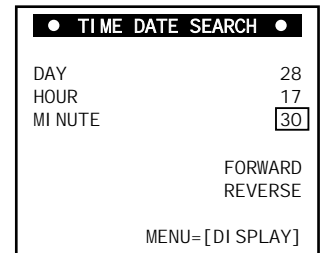
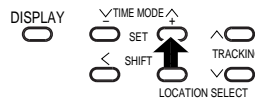

3 Press the **SET** button to set the DAY to 28 and press the **> SHIFT** button.

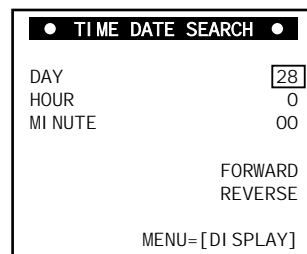
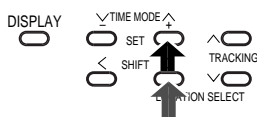

6 Press the **SHIFT** button to blink the REVERSE, and press the **SET** button.

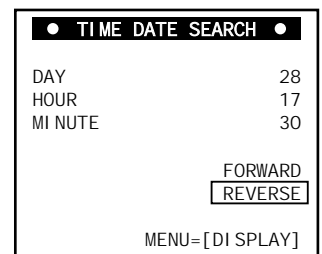
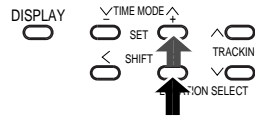

Note:

- Time date search is not carried out if the time adjustment has been not completed.
- Time date search is not carried out for tapes recorded by a unit which can't automatically record data of time and date.
- Time date search will not operate when searching a section of tape that has an alarm on it. In this case perform alarm search.
- Time date search may cause a time error listed in the following to the specified time.
- Time date search may not be carried out in the areas at REC start and REC end shown below.

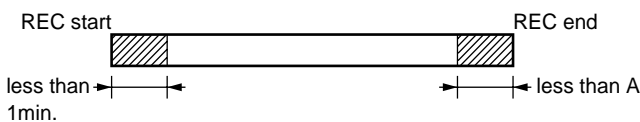

Record mode	A (Not carry out in the REC end area at maximum)	Time error to the specified time at maximum
A2, A6, A12, A18, A24, 24	1 min.	1 min.
48, 72	3 min.	3 min.
120	4 min.	4 min.
168	5 min.	5 min.

ALARM SEARCH

With the alarm search function, it is possible to search for alarm that has been recorded on the tape.

Search Operation

1 Press the **STOP** button.

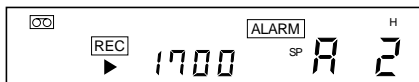

2 Press the **COUNTER MEMORY** button twice to make "ALARM M" to light.

3 Turn the **SHUTTLE** dial to set rewind or fast forward.

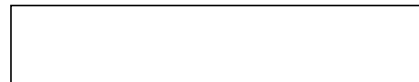

When the tape reaches the alarm recorded position, The VCR automatically enters the still picture mode.

4 Press the **PLAY** button.

NOTICE

SIGNAL LEVELS OF INPUT/OUTPUT TERMINALS

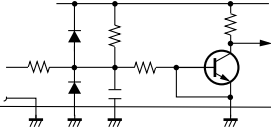
Input/Output Terminal	Signal level	Additional remarks
ALARM IN		
ALARM RESET		
ALARM OUT		
REC TRIGG. OUT		
TAPE END OUT		
ONE SHOT IN	IN10010K10K10K10K0001 mGNDDC5V200 ms or greater	Ground input 0V -50.5V Open IN10010K10K10K10K0001

NOTICE

DAILY AND PERIODIC INSPECTION

This VCR has been designed to stand the use over long periods. Nevertheless, we recommend you to carry out regular daily inspection to insure problem-free use.

Note:

It is particularly important to carry out daily checks when using the VCR for repeat recording.

Order of Daily Checks

1 Turn the power ON for this VCR and for the connected devices in the surveillance system including the video camera and monitor TV.

6 Press the **PLAY** button.

2 Does the correct picture appear in the monitor TV?

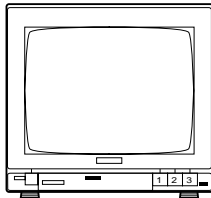

7 Is the playback picture normal?
Is there anything abnormal about the recorded date and time?

3 Is the date-time display correct on the monitor TV?

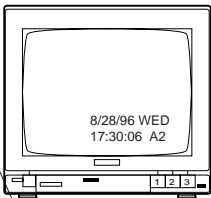

8 Press the **REC** button.

4 Rewind the tape several digits on the screen you recorded the previous day.

9 Check the playback picture recorded in A2 hour mode.

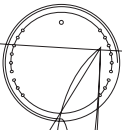

5 Press the **TIME MODE** button to go to the A2-hour mode.

10 After checking these matters change to the mode you want to set to.

Steps to Take after Daily Checks

If an abnormality is found, turn the power switch to OFF and remove the power plug from the household AC outlet. Then consult with your dealer.

A Request for Periodic Checks

- This VCR includes a time gauge to display the total usage time. The total usage time is displayed on the SETUP (2) screen. Periodically make sure the usage time.

Total time: Max. 99999 hours
(approximate value)

Time since the last maintenance: Max. 9999 hours
(approximate value)

- Regularly clean and replace parts in this VCR using the displayed usage times as a guide. For further details, consult your dealer.

- Press the **DISPLAY** button.

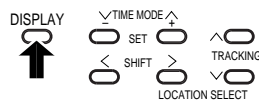

- Press the **SHIFT** button to blink SETUP and press the **SET** button.

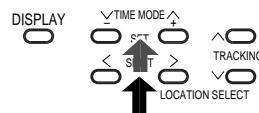

- Press the **< SHIFT** button to change to SETUP screen (2).

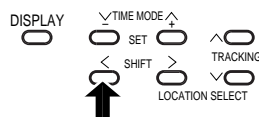

Tape Usage Frequency

Replace tapes using the table below as a guide.

Recording time mode	Usage frequency		Recording time mode	Usage frequency	
	(Using T-120)	(Using T-160)		(Using T-120)	(Using T-160)
A2	100	50	48	10	5
A6	100	50	72	7	3
A12	40	20	120	4	2
A18	33	16	168	3	1
A24	20	10	L01 ~ L03	1	
24	20	10			

CAUTIONS DURING USE

Dew Condensation

This VCR includes a safety function to prevent operation when dew condensation occurs and thus protects against damage to tapes, the video heads and other parts.

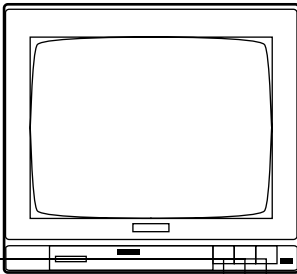

- **What is condensation?**
If you pour cold beer in a glass, water droplets gather on the surface of the glass. This phenomenon is known as condensation.
- **When condensation occurs.**
If you continue to use the video device in this state, the tape will cling to the internal parts of the VCR, causing damage to the tape and video heads.

BEFORE CALLING SERVICE PERSONNEL

If you suspect a breakdown, check the following points before calling your serviceman for follow-up service.

Installation	
Power does not go ON.	■ Is the power plug securely inserted to an AC outlet?
There is no camera picture.	■ Is the VCR properly connected to the TV, video camera and other devices? ■ Is there any problem with the connection of the connecting cords?
The camera picture is indistinct.	■ Is the camera properly focused?
Function/Operation	
The VCR does not operate even when the control buttons are pressed.	■ Has a video tape been inserted? ■ Is the REMOTE switch OFF? ■ Is the Dew lamp blinking? The VCR is not operating because the safety functions are operating. Wait until the blinking stops with the Power switch ON.
The clock does not run after restoration of power following a power failure.	■ Has the VCR's power plug been removed from the AC outlet for a long period? Insert the power plug in the AC outlet and carry out continuous charging for 48 hours or longer.
The buzzer does not sound.	■ Is the BUZZER switch set to OFF? If off, the buzzer does not work.
Recording	
Playback, fast forward and rewind are possible but recording is not possible.	■ Is the tab on the video cassette broken off? ■ Is the video tape at tape end?
Recording has stopped.	■ Have more than 10 minutes passed since pressing the PAUSE button during recording?
Nothing is being recorded.	■ Have you been carrying out regular daily checks? If this phenomenon occurs often, something may be broken. Consult with your dealer.
Not possible to record after restoring power following a power failure.	■ Is restart recording OFF? ■ Has the power failure lasted for longer than 10 days?
Repeat recording is not possible.	■ Is TAPE END MODE on REW→REC? ■ Has one of the operations buttons been pressed during automatic rewind? ■ Is TAPE END ALARM on CONT?
Timer recording is not possible.	■ Is the present time setting correct? ■ Is the timer setting correct? ■ Has the TIMER button been pressed? ■ Did a power failure continue for a long period after the timer was set? ■ Has the POWER switch been turned ON? ■ Has the power plug been removed from the AC outlet?
Alarm recording is not possible.	■ Are the alarm sensor and the alarm input properly connected?

Playback

There is excessive noise in the playback picture.	■ Adjust with the TRACKING button.
The playback picture is not clear.	■ The video head may be clogged or worn out. Consult with your dealer.
The time-lapse mode playback picture or still playback shakes up and down.	■ Press the TRACKING button in a still playback mode and adjust.
Two recorded sections appear in the playback picture when using several video cameras and changing cameras.	■ Are you using an external synchronous or gen-lock synchronous video camera? Consult with your dealer.
When the VCR power plug is inserted to the AC outlet, recording starts and playback is not possible.	■ Is restart recording set to ON?

Other matters

No screen display appears.	■ Has DISPLAY MODE been set? ■ Is the On-Screen position correct?
Recording does not continue automatically after restoring power following a power failure.	■ Did the power failure continue for more than 10 days?
Black/white picture appears in playback through color camera signals are recorded.	■ Playback is carried out with the VIDEO MODE switch set to B/W position. ■ Recording is carried out with the VIDEO MODE switch set to B/W position.
Pictures are colored in playback through black/white camera signals are recorded.	■ Playback is carried out with the VIDEO MODE switch set to COLOR position. ■ Recording is carried out with the VIDEO MODE switch set to COLOR position.

Cautions:

- Do not install the VCR in a location near heat sources, such as radiators or air ducts, or in a place subject to direct sunlight, excessive dust, mechanical vibrations or impacts.
- Allow adequate air circulation to prevent internal heat build-up. Do not place the VCR on soft surfaces (rugs, blankets, etc.), too near materials such as curtains and draperies or in a built-in installation such as a bookcase or rack.
- Keep the VCR and the video cassettes away from strong magnetic fields.
- To disconnect the lead, pull it out by the plug. Never pull the lead itself.
- Do not drop any inflammable or metallic objects, or liquid into the VCR. This may cause damage to the VCR.
- Do not hit or shake the VCR when moving it. This may cause damage.
- Remove the cassette from the VCR when not in use.
- Save the original carton and packing materials: they will come in handy if you ever have to transport your VCR. For maximum protections, repack the VCR as it was originally packed at the factory.
- Do not use volatile liquids such as insect spray near the VCR.
Do not leave rubber or plastic products touching the VCR for a long time. They will damage the finish.

Notes:

- When the TIME MODE is changed during recording, noises will occur for an instant on the screen and sound at that the TIME MODE changed area in the playback.
- When the TIME MODE is changed during playback, noises will occur for an instant on the screen and sound.
- In the cases shown below, the VCR sets the power on first for 1 ~ 2 s, and turns the power to off with display "OFF".
 - When the ALL clear button is pressed.
 - When the power cord plug is connected after disconnected during the VCR display "OFF".
 - When the power supply is resumed from power failure during the VCR display "OFF".

SPECIFICATIONS

Power supply	120V AC, 60 Hz
Power consumption	18W
External dimensions	17 × 3-5/8 × 12-1/2 inch (W × H × D), 430 × 92 × 318 mm (W × H × D)
Weight	11 lbs (5.0 kg)
Signal system	Standard NTSC color television system
Recording System	Rotary 2-head azimuth
Cassette	VHS marked, 1/2 inch cassette tape
Tape speed	A2-hour mode: 33.35mm/s, A6-hour mode: 11.12mm/s
Recording/playback time mode	A2/A6/A12/A18/A24/24/48/72/120/168 hours (when T-120 is used)
Fast forward/rewind time	Within 2 minutes (when T-120 is used)
Video input (BNC)	1.0V(p-p), 75 Ω Unbalanced Luminance signal
Video output (BNC)	1.0V(p-p), 75 Ω Unbalanced Luminance signal
Horizontal resolution	350 lines (monochrome mode), 300 lines (color mode) (A2-hour mode)
Video S/N	More than 45 dB (A2-hour mode): monochrome mode More than 43 dB (A2-hour mode): color mode
Audio input	Line input: 308mV (rms), more than 47k Ω, pin jack Microphone input: 0.245mV (rms), less than 5k Ω, ø3.5 jack
Audio output	388mV (rms), less than 4.7k Ω, pin jack
No. of audio tracks	1 track
Audio frequency characteristics	100 Hz to 10 kHz (A2-hour mode)
Audio S/N	More than 43 dB (A2-hour mode)
Operating conditions	Temperature: 41°F to 104°F (5°C to 40°C) Humidity: less than 80%
Storage conditions	-4°F to 140°F (-20°C to 60°C)
Connector section	
Alarm input	Ground input: 0 to 0.5V
Alarm reset input	Ground input: 0 to 0.5V
Alarm output	DC 5V, impedance: 220 Ω, less than 10mA
Recording trigger output	During time lapse: 0/5V negative pulse signal A2 and A6-hour mode: 0V Alarm recording: 0/5V (Programmable) Except above-mentioned: 5V
Tape end output	Open/Short, impedance: 220 Ω, less than 20mA
One shot input	Ground input: 0 to 0.5V

Design and specifications are subject to change without notice.

Accessories

- Instruction manual (1)
- Warranty card (1)
- Dew caution sheet (1)

TOSHIBA AMERICA C.P. INC.

CCTV GROUP
VIDEO COMMUNICATION & INFORMATION
SYSTEM DIVISION
1010 Johnson Drive
Buffalo Grove, Illinois 60089-6900
(708)541-9400